

GH-625XT

User Manual

Version 2.0



Table of Content

1. INTRODUCTION AND FEATURES	4
1.1 INTRODUCTION.....	4
1.2 FEATURES	4
2. SPECIFICATION	5
3. HARDWARE OVERVIEW	6
3.1 PACKAGE CONTENTS.....	6
3.2 BUTTON INTRODUCTION	7
3.3 ANTENNA INTRODUCTION	8
3.4 BATTERY CHARGER DESCRIPTION	8
3.5 HOW TO USE HEART RATE MONITOR.....	9
3.6 MOUNT THE BIKE HOLDER	10
3.7 WATCH MODE SETTING.....	11
3.8 SYMBOL EXPLANATION.....	12
4. GETTING START	13
4.1 STARTING UP YOUR GH-625XT.....	13
4.2 CHANGE THE PAGE	13
4.3 GETTING START A TRAINING AND SAVING	14
5. Menu Structure - Main Menu	19
6. Activity	20
6.1 ACTIVITY INFO.....	20
6.1.1 TRAINING INFO	20
6.1.2 MULTISPORT	21
6.2 SETTING.....	22
6.2.1 AUTO HOLD.....	22
6.2.2 ALERTS.....	22
6.2.3 CALORIES	23
6.2.4 LAP SETTING.....	24
6.2.5 Data Recording	24
6.3 DELETE ALL	25
6.4 MEMORY STATUS.....	25
7. GYM	26
7.1 TRAINER	26
7.1.1 DIST / TIME	26
7.1.2 DIST / SPEED	27

7.1.3 SPEED / TIME	27
7.1.4 PACE / DIST	29
7.1.5 YOURSELF	29
7.2 MULTISPORT	30
7.3 INTERVAL TRAIN.....	32
7.3.1 CREATE WORKOUT.....	32
7.3.2 LIST ALL	32
7.3.3 DELTE ALL.....	33
8. NAVIGATION	33
8.1 ADD MAP MODE / REMOVE MAP MODE	33
8.2 ROUTES	34
8.2.1 LIST ALL	34
8.2.2 DELETE ALL.....	35
8.2.3 ROUTES SETTING	35
8.3 SAVE WAYPOINT	35
8.4 FIND WAYPOINT	36
8.4.1 LIST ALL	36
8.4.2 DELETE ALL.....	37
8.5 RETURN TO START /STOP GOTO.....	37
9 CONNECT TO PC	37
10 CONFIGURATION.....	38
10.1 USER PROFILE	38
10.2 SET CUSTOM PAGE	38
10.3 SET SYSTEM.....	39
10.4 UNITS	40
10.5 CARDIO SET	40
10.5 GPS SETTINGS.....	41
10.6 MAP MODE SET	42
10.7 FACTORY RESET	42
10.8 SYSTEM UPGRADE	42
10.9 ABOUT PRODUCT.....	42
11.Glossary.....	43
12. Troubleshooting & FAQ	44

Thank you for purchasing GS-Sport GH-625XT. We sincerely hope you to enjoy using this high technology GPS device. For fully understand the functions and features of GH-625XT, please read the user manual before you get started.

1. INTRODUCTION AND FEATURES

1.1 INTRODUCTION

GS-Sport GH-625XT is a stylish, fully-sealed, wrist type GPS device. GH-625XT is a multi-use GPS sports training watch that can be used in most any outdoor application likes running, swimming, triathlon ..., to monitor, track and analyze your exercise and training routines or simply to log traveled routes, information is displayed using the included Training Gym program, or exported into popular formats such as GPX, CVS, TXT or KML for use with other popular web-sites, and software. Training tools such as alarms for distance, lap times, speed, heart rate, calorie burn calculations, heart rate monitor and bread crumb trails for easy back-track to origin points, makes the GH-625XT a must have.

1.2 FEATURES

- The main features of GH-625XT
- Slim type compact and watch design
- Built-in SiRF Star IV high performance GPS chipset and support emperies prediction to make always stay hot start situation.
- Embedded high resolution display for easy read under sunlight.
- Trainer mode : Assistant trainers to improve performance
- Interval Training: To enhance personal condition to accustom specify activities like soccer or hockey.
- Smart Track Back: To guide point by point to make you never get lost.
- Mutisport: Allow you to set different sport into one program for training.
- Support both TOD mode and clock alarm function and can be used as real watch over 5 days.
- Built in rechargeable Li-ion poly battery
- Over 18 hours in operation mode.
- Support virtual trainer, multiple sports and interval training.
- Support 5KHz Heart Rate Monitor.

2. SPECIFICATION

Electrical and Mechanical Parameters General		
Item	GH-625XT	
Number of Trackpoints	120,000	
LAP	6,000	
Number of Waypoints	100	
Display Size	24.9 x 39.88 (H x W in mm.)	
Display type	4 gray color LCD	
Pixels (H x W)	128x96	
Unit Weight	83 g	
Water resistance Standard	IPX7	
Unit Size	76.5 x 61.5 x 17.5 (L x D (Φ)x H in mm.)	
Backlight Display	Single level	
Operating temperature	-10°C – 60 °C	
Humidity	5% to 95% Non-condensing	
Voltage	3.7V for a rechargeable battery, 5V for charging input;	
Charging connector	DC 5V	
Battery	Rechargeable Li-Polymer	
Battery life	GPS on (3D fixed); Backlight off	≥18 hours
	GPS on (3D fixed); Backlight on	≥15 hours
	TOD Mode	Over 5 days
Connect to PC Interface	USB to DIN4 cable	
Charger	2.5 hours completed charging	
GPS Parameters General		
GPS Chipse	SiRF Star IV	
Frequency	L1, 1575.42 MHz	
C/A code	1.023 MHz chip rate	
Channels	48 track verification channels	
Antenna Type	Built-in Patch antenna	
Position	10 meters, 2D RMS	
	5 meters, 2D RMS, WAAS enabled	
Velocity	0.1 m/s	
Time	1 us synchronized to GPS time	
Default datum	WGS-84	
Reacquisition	0.1 sec., average	

Hot start	1 sec., average
Warm start	38 sec., average
Cold start	42 sec., average
Altitude	18,000 meters (60,000 feet) max.
Velocity	515 meters/ second (1000 knots) max.
Acceleration	Less than 4g
Jerk	20 m/sec ³

3. HARDWARE OVERVIEW

3.1 PACKAGE CONTENTS

Check the contents of your GH-625XT package. If you find any accessories are missing or appear damaged, please contact your dealer immediately.



GH-5625XT



Extended watchband & Screwdriver



USB Clip



CD-ROM

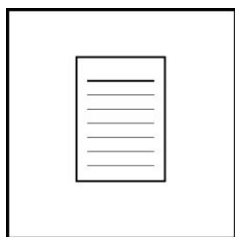

Quick Guide



Bike Holder (optional)

3.2 BUTTON INTRODUCTION



Button	Description
ESC/LAP	In Menu mode, press ESC button to escape from the current page and go back to the previous page. Press ESC button to split a lap when timer is running.
Power/Backlight	Press 2 seconds to turn on/off GH-625XT. When GH-625XT is turn on, quickly press this button will turn on/off the backlight. Press and hold this button for 14 seconds to do hardware reset if the system is halted.

PG (Page)	Switch between the screens of "Menu mode", "Location mode", "Speedometer mode" and "Map mode".
Up / Down	To move upward/downward for highlighting an item. In Speedometer mode, press to switch between two views. In Map mode, press to zoom in or zoom out.
OK / Enter	Press to enter the highlighted item. Press to confirm data entry or feature selection in Menu mode. In Speedometer mode, press to start/stop the timer.

3.3 ANTENNA INTRODUCTION

The GPS antenna is located in the lower part of the device. Let it face to the sky for a better reception.



3.4 BATTERY CHARGER DESCRIPTION

GH-625XT operates by a built-in Li-ion rechargeable battery. A battery icon shown on the left bottom corner of screen indicates the remaining battery power.

Inside the USB socket, there is a small "bar" on the right side.

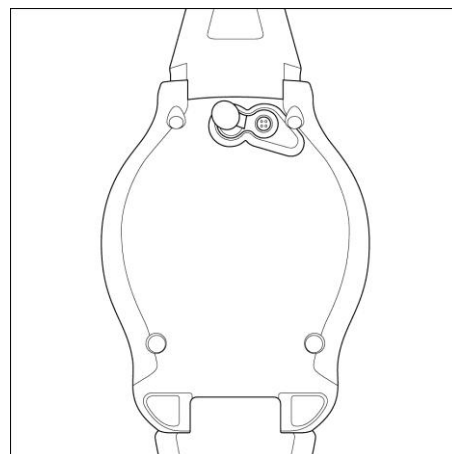

There is a "groove" on the side of the column of USB connector.

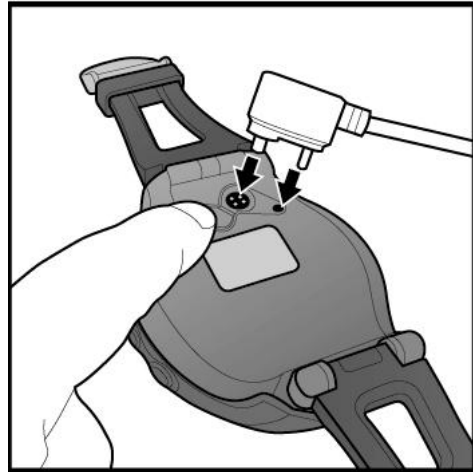

Aim the "groove" at the "bar" for plugging in the USB connector.

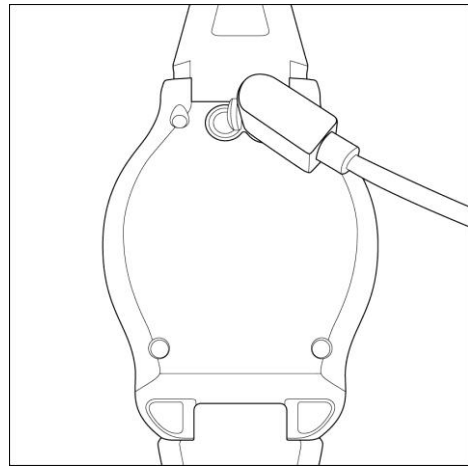

To charge the battery:

1. Connect one end of USB clip with your GH-625XT and the other end with the AC adapter or USB port on PC.
2. It may need about 2.5 hours to fully charge the battery.

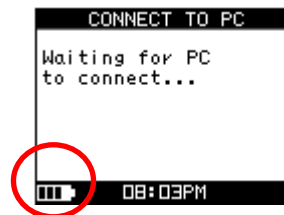

3.5 HOW TO USE HEART RATE MONITOR

Wear the Heart Rate Monitor (only for GH-625XT)

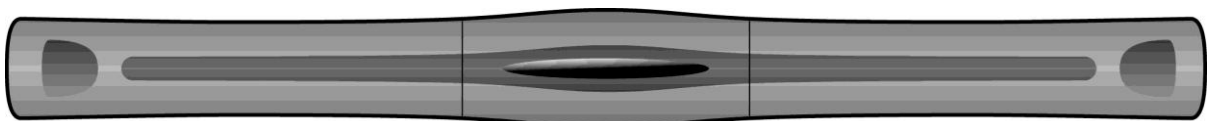

Outer side

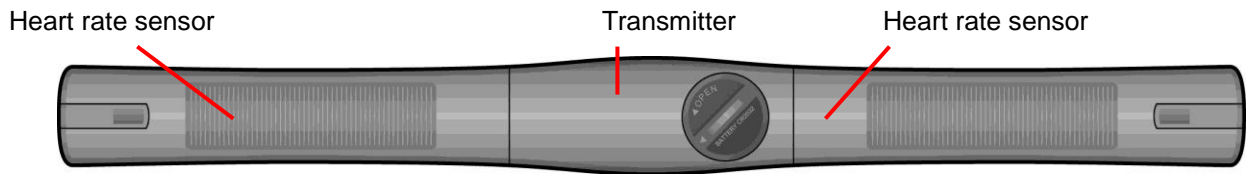

Inner side.

Cling this side to your skin. You can wet the sensor to obtain a better reception of your pulse.

1. Put one end of the strap through the slot of the heart rate monitor first.
2. Wrap the heart rate monitor and strap around your chest. Adjust the heart rate monitor to be at the center of your chest.
3. Adjust the strap to fit your chest and make it tight enough to prevent dropping while you are jogging.
4. Put another end of the strap through the slot of the heart rate monitor to finish the wearing.

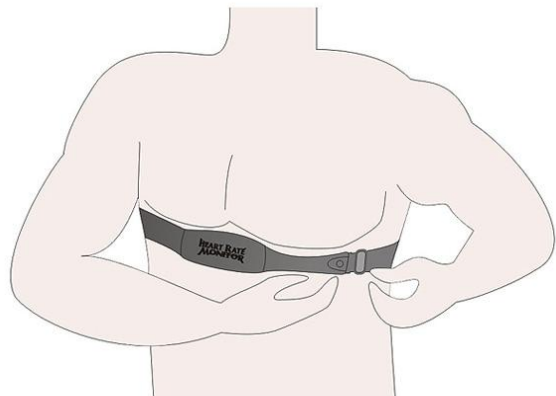
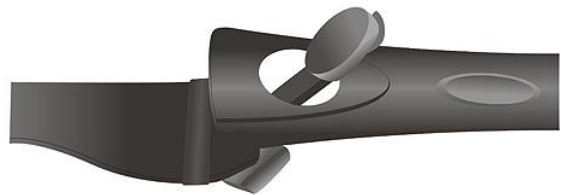

3.6 MOUNT THE BIKE HOLDER

1. Buckle up the bike holder on the bike.

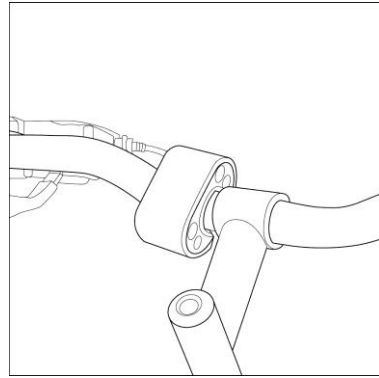

2. Bind up the GH-625XT strap.
Test the stability by twisting the watch set.

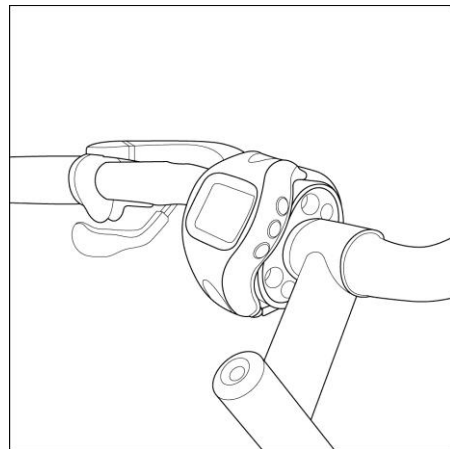

3.7 TIME OF DATE MODE SETTING

1. GH-625XT supports TOD mode after a while for non usage in order to save more power.
2. You may go to CONFIGURATION>SET SYSTEM>TOD MODE to enable this function.
3. System will upon the TIME for non usage to enter the TOD MODE.
4. You may press PG button and Down button at the same time for 2 seconds to escape the TOD MODE.





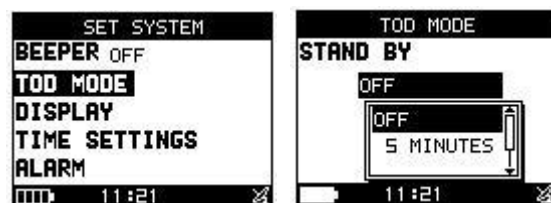

OR





3.8 SYMBOL EXPLANATION



Icon picture	Description	Indication
	Battery capacity indication	The remaining battery power
	timer icon	When you stop the timer, the icon will be flashing. If it is auto paused, you will see the icon flashing
	Clock alert	This icon will show up when you set the alarm clock for WEEKEND, WEEKDAY, DAILY...or OFF
	satellite icon	GPS status indicator <ul style="list-style-type: none"> ● Flash: No signal ● Solid: 3D fix
	Heart Rate Alarm Zone indicator	There are three numbers to indicate Heart Rate Alarm Zone, press PG for 5 sec to switch.

4. GETTING START

4.1 STARTING UP YOUR GH-625XT

Press the Power button for 2 seconds to turn on the device. You will see the welcome screen displayed. Allow the GH-625XT a short time to track satellites for the first time you use it. Take your GH-625XT to the outdoor open space with a clear view to the sky and it will be easy to acquire satellite signal with a few seconds. If the device can't get 3D fixed, you can still press PG button to exit the Locating screen. To turn off your GH-625XT, press the Power button for 2 seconds. If the system frozen, press power button over 10 seconds to do hardware reset.



4.2 CHANGE THE PAGE

Press PG button to switch between different modes

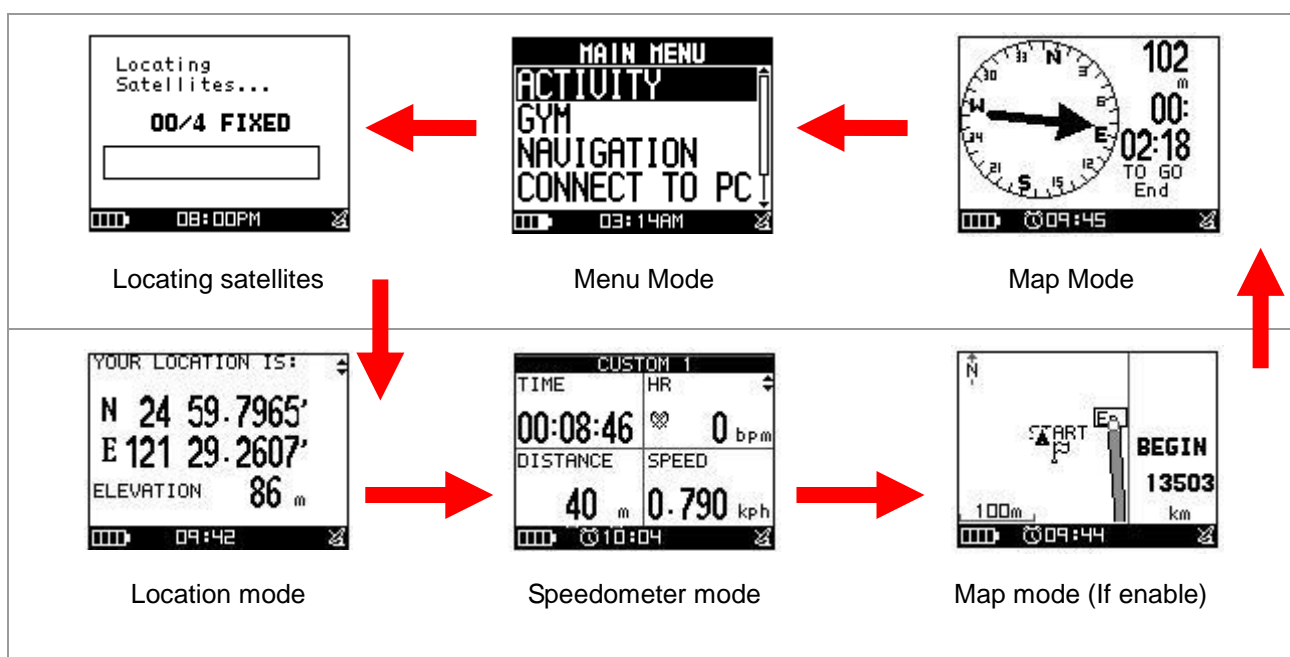

4.3 GETTING START A TRAINING AND SAVING

To start training by "OK" key and you also can split laps by press "LAP" key while in training

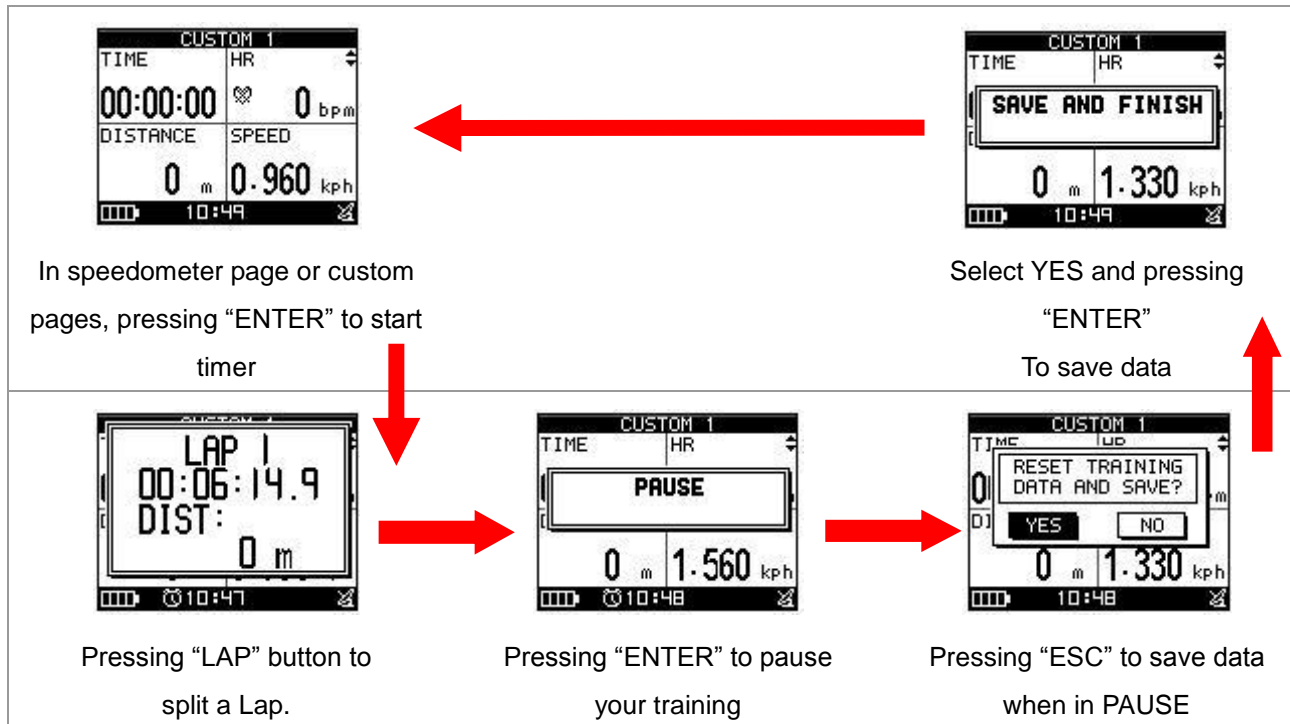

4.4 Your personal coach : GYM

In order to improve your training performance, GH-625XT provides GYM to pretend your coach to improve your performance through mutual training and reaction.

[MAIN MENU] > [GYM]

<p>There are three major subjects for personal training</p> <ul style="list-style-type: none"> ◆ Trainer ◆ Mutisport ◆ Interval Training 	
<p>TRAINER</p>	
<p>There are five types to set your training partner.</p> <ul style="list-style-type: none"> ◆ Dist / Time ◆ Dist / Speed ◆ Speed / Time ◆ Pace / Dist ◆ Yourself 	

- To set up your target trainer parameters through setting for distance, time, speed, pace or specified training file accordingly. The trainer will according to the setting to race with you.
- Finished setting, press "Up or Down button" to select "Start" and then press "Enter button" to start.

Dist / Time



Dist / Speed

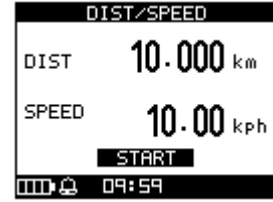
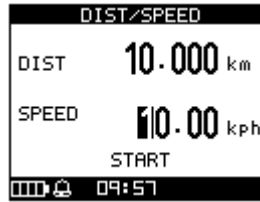

Speed / Time

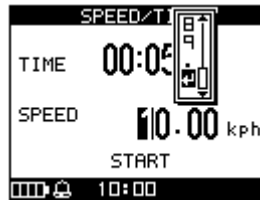

Pace / Dist



Yourself

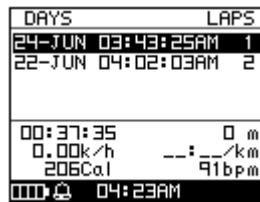

- When you decided to START the race, the competition window will pop up. System will ask you the whether to record this race and give an alarm during race.



[REST DIST] The rest of distance
 [BEHINE /AHEAD] The status of competition
 [YOURSELF] The finished percentage of yourself
 [TRAINER] The finished percentage of trainer



MUTISPORT

Mutisport could be used on composite activities competition; you could set running, biking, or others for your personal training.

Trainer can make a Transition or switch to next sport by pressing "UP" key 3 seconds.

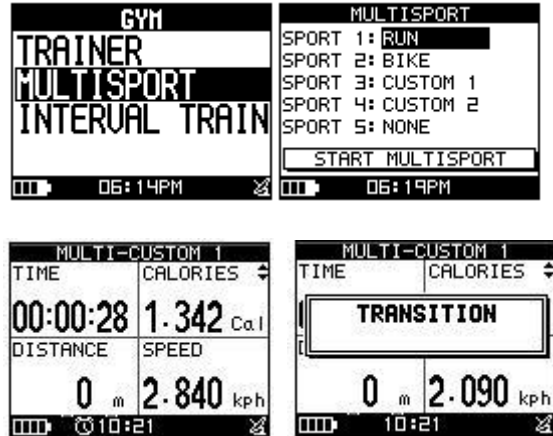

INTERVAL TRAINING

Several activities likes hockey or soccer need this kind particular training.

Trainer can create a new workout and then insert interested session into the program.

Trainer may select the interest workout to go for training. System will according to setting to run the program as well as LAP is functional.



4.6 How to Use Smart Track Back

To use track can guide you go back along your training record and make you never get lost.

[MAIN MENU] > [ACTIVITY] > [ACTIVITY INFO]

1. You will see all data you saved, press "Enter button" to enter.
2. Click "TRACK BACK?" and then press "Enter button".
3. Chose "Backward" or "Forward" to start your track back. It will take some times to compress the record in order to optimize the memory usage.
4. The screen will show map. Sometimes you may press OK or ESC button to skip or back the waypoints if you locate the intercross section. You may also go to MENU mode to NAVIGATION>ROUTES> ROUTES SETTING to enable AUTO JUMP, if you would like to have system to recognize the closest point to switch then.
5. Press "Page button" display the distance and time for you to reach destination on the right part of screen. The direction of destination waypoint is shown by the arrow sign of the compass.

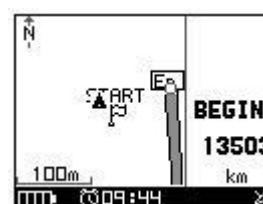
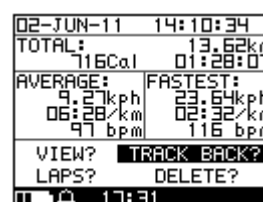
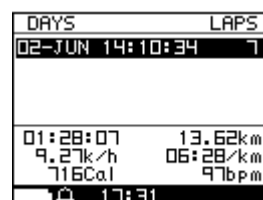

4.7 Bibliography

Item	Description
ALTIUDE	Current altitude
ALTI MAX	The highest altitude
ALTI MIN	The lowest altitude
CALORIES	shows how many calories you have burned
CAL RATE	Burn calories per hour
HR	Instant heart rate information
HR AVG	Average heart rate information
HR INZN	Heart rate zone
HR MAX	The max hear rate information
LAPS	Lap counts
LAP DIST	Lap distance
LAP PACE	The average pace for the last lap
LAP SPEED	The average speed for the last lap
LAP TIME	The time spent for the last lap
PACE	the time needed for one mile or one km
PACE AVG	Average pace
PACE BEST	The fastest pace
PACE INZN	Pace zone
SPEED	Instant speed
SPEED AVG	The average speed.
SPEED MAX	Max speed
SPEED INZN	Speed zone
TIME	Time
DISTANCE	shows how far you have trained
Asc SPEED	Ascending speed
CUMULATE +	Raise accumulative altitude
CUMULATE -	Falling accumulative altitude
REST DIST	The rest of distance to go
REST TIME	The rest of time to go
PACER	Evaluated time between trainer to virtual trainer
PACER E	Evaluated rest distance to destination
PACER T	Evaluate rest time to destination
SLOPE	The tilt percentage from vertical to horizontal

5. Menu Structure - Main Menu

This diagram presents all the available menu options for your quick look up.

ACTIVITY	ACTIVITY INFO	TRAINING INFO	
		MULTISPORT	
		AUTO HOLD	
	SETTING	ALERTS	TIME/DIST ALERT
			SPEED/PACE ALERT
			HEART RATE ALERT
			SETTING
		CALORIES	
		LAP SETTING	
		DATA RECORD	
	DELETE ALL		
	MEMORY STATUS		
GYM	TRAINER	DIST / TIME	
		DIST / SPEED	
		SPEED / TIME	
		PACE / DIST	
		YOURSELF	
	MULTISPORT		
	INTERVAL TRAIN	CREATE WORKOUT	
		LIST ALL	
DELETE ALL			
NAVIGATION	ADD MAP MODE / REMOVE MAP MODE		
	ROUTES	LIST ALL	
		DELETE ALL	
		ROUTES SETTING	
	SAVE WAYPOINT		
	FIND WAYPOINT	LIST ALL	
		DELETE ALL	
RETURN TO START / STOP GOTO			
CONNECT TO PC			
CONFIGURATION	USER PROFILE		
	PAGE SETTING	SET PAGE 1	
		SET PAGE 2	
		SET PAGE 3	

		SET PAGE 4
		SET LAP PAGE
SET SYSTEM		BEPPER
		TPD MODE
		DISPLAY
		TIME SETTINGS
		ALARM
UNITS		UNIT
COORDINATION		
CARDIO SET		
GPS SETTINGS		WAAS / EGNOS
		GPS
		GPS INFO
MAP MODE SET		
FACTORY RESET		
SYSTEM UPGRADE		
ABOUT PRODUCT		

6. Activity

6.1 ACTIVITY INFO

6.1.1 TRAINING INFO

Personal training records will be located into this session.

[MAIN MENU] > [ACTIVITY] > [ACTIVITY INFO] > [TRAINING INFO]

- Use Up and Down button to scroll to the item you wish to display and press "Enter button" .
The all training data information will display:
- Use Up and Down to select the file you wish to check and press "Enter button, the training data information is shown on the screen.

DAYS		LAPS	
02-JUN 14:10:34		7	
01:28:07		13.62km	
9.27k/h		06:28/km	
716Cal		97bpm	
17:45			

Information items are displayed:

- Date and Time.
- Total distance of this training.
- Total calories you have burned.
- Total time of this training.
- Average speed of this training.
- Fastest speed of this training.
- **VIEW?** Display this training data on the screen.
- **TRACK BACK?** You can track back to the BEGIN point or END point of this training route. When the Track Back is active, you may press OK or ESC to go to next or previous waypoint.
- **LAPS?** View the LAP details on map mode.
- **DELETE?** You can delete this training data.

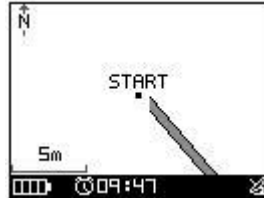

LAPS	TIME
1	24:10:25 24:10:25
2	24:10:26 00:00:01
24:10:25.2 223 m	
0.01k/h --:--/km	
11Cal 93bpm	
04:46AM	

6.1.2 MULTISPORT

Muti-sport training records will be located into this session.

[MAIN MENU] > [ACTIVITY] > [ACTIVITY INFO] > [MULTISPORT]

1. Use Up and Down button to scroll to the item you wish to display and press "Enter button".
The all training data information will display:

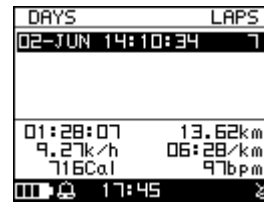

2. Use Up and Down to select the file you wish to check and press "Enter button, the training data information is shown on the screen.



- **TRACK BACK?** You can track back to the BEGIN point or END point of this training route.
- **DELETE?** You can delete this training data.

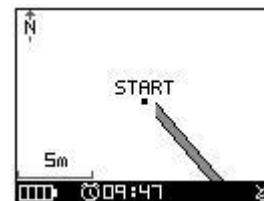

6.2 SETTING

6.2.1 AUTO HOLD

[MAIN MENU] > [ACTIVITY] > [SETTING] > [AUTO HOLD]

1. The Auto Hold function allows you to pause the timer automatically when you stop moving or your speed falls below a certain value.
2. When the timer is paused, the data is not recorded. Thus the average speed and calories calculation could be more accurate.

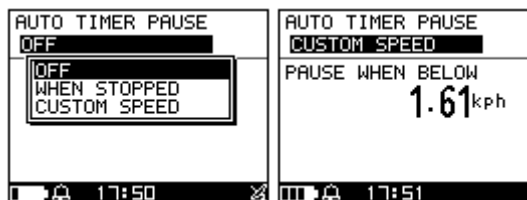

6.2.2 ALERTS

> 6.2.2-1 TIME / DIST ALERT

[MAIN MENU] > [ACTIVITY] > [SETTING] > [ALERTS] > [TIME/DIST ALERT]

1. Use Up and Down button to select the item and press OK to modify it.
2. You can set the alarm to sound once when the specified time is reached, or repeat to sound on every specified time, or turn it off.
3. You can set the alarm to sound once when you reached the specified distance, or repeat to sound on every specified distance, or turn it off.

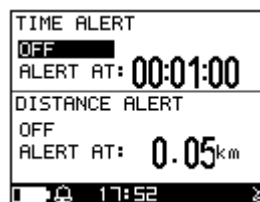

> 6.2.2-2 SPEED / PACE ALERT

[MAIN MENU] > [ACTIVITY] > [SETTING] > [ALERTS] > [TIME/DIST ALERT]

1. Use Up and Down button to select the item and press OK to modify it.
2. You can set the alarm to sound when your speed or pace is above or below a specified value.

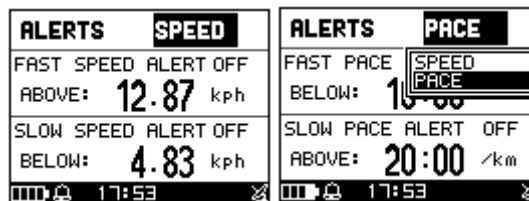

> 6.2.2-3 HEART RATE ALERT

[MAIN MENU] > [ACTIVITY] > [SETTING] > [ALERTS] > [HEART RATE ALERT]

1. Use Up and Down button to select the item and press OK to modify it.
2. You can set the alarm to sound when your HR ZONE / CUSTOM setting is above or below a specified value or OFF alarm.

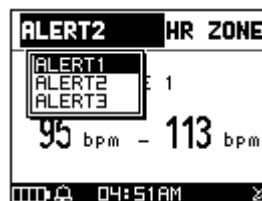
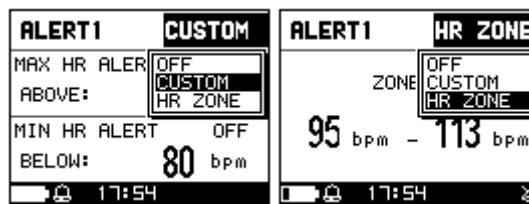

3. Heart Rate Alert supports 3 regions setting, when training is start, the Heart Rate Alarm region indicator will appear in Speedometer page.
4. Trainer may press “UP” 3 key seconds to switch Heart Rate Alarm region.

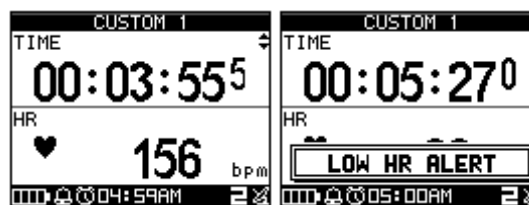

➤ **6.2.2-4 SETTING**

[MAIN MENU] > [ACTIVITY]> [SETTING] > [ALERTS] > [SETTING]

To select the alerts sign with message /beeper or symbol/beeper.



6.2.3 CALORIES

[MAIN MENU] > [ACTIVITY]> [SETTING] > [CALORIES]

SPORT TYPE

Select sport type from "Walking", "Hiking", "Running", "Biking" or "By Time" by press UP and Down button.



TRAINING LEVEL

Select training level depend on your sport type, the default setting is Middle.

**EXTRA WEIGHT**

1. Confirm the extra weight you carry and then input to EXTRA WEIGHT item.
2. System will calculate the calories consumption depending on the specified sport type.

**6.2.4 LAP SETTING**

[MAIN MENU] > [ACTIVITY]> [SETTING] > [LAP SETTING]

There are five selections for setting.

◆ OFF

Disable LAP function.

◆ DISTANCE

LAP trigger by specify distance.

◆ BY TIME

LAP trigger by specify time.

◆ BY POINT

LAP trigger by specify location where you start training.

◆ GPS OFF LAP

To save more power and use the watch as a normal training watch with LAP function. When LAP key was active, system will account into an additional lap and distance will be taken into training according to setting. GPS will be disable in this period.

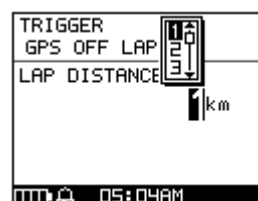
**6.2.5 Data Recording**

[MAIN MENU] > [ACTIVITY]> [SETTING] > [DATA RECORDING]

1. System is default to record one point for every second. This will create the most accurate record for your training activity. However, you can set a different interval to record the points.

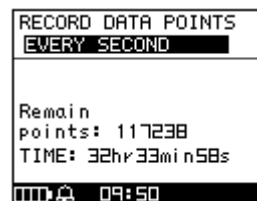

2. Set the longer interval means less data in a fixed period of time. But you can use the device for a longer time.
3. Indoor Training means to record training data with Heart Rate without GPS fix.



6.3 DELETE ALL

[MAIN MENU] > [ACTIVITY] > [DELETE ALL]

You can delete all the training data stored in the device.



6.4 MEMORY STATUS

[MAIN MENU] > [ACTIVITY] > [MEMORY STATUS]

You will see how many points left and the remaining time you can use. The remaining time depends on the period of your record setting.



7. GYM

In order to improve and enhance your training performance. GH-625XT provides GYM to pretend your coach to improve your performance through mutual training and reaction.

7.1 TRAINER

7.1.1 DIST / TIME

[MAIN MENU] > [GYM] > [TRAINER]>[DIST / TIME]

The distance for 10 km and time for 5 minutes which means the virtual trainer will finish 3km within 15 minutes to compete with you.

1. You could change DIST / TIME to set up your goal.



2. Finished setting, press "Up or Down button" to select "Start" and then press "Enter button" to start.



3. Your training performance will shown on the device including REST DISTANCE, CURRENT PROGRESS(BEHINE OR AHEAD), YOURSELF PERFORMANCE AND TRAINER PERFORMANCE.



4. Press ESC button for recording your lap info.



5. Press Enter button for 2seconds will exit this training . REALLY WANT TO STOP ?.



7.1.2 DIST / SPEED

[MAIN MENU] > [GYM] > [TRAINER] > [DIST / SPEED]

Set distance for 10 km and speed for 10km/hr which means you have to keep your speed over 10km/hr.

1. You could change DIST / SPEED to set up your goal.

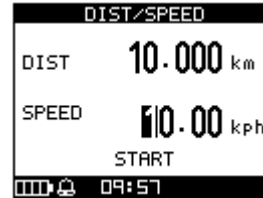

2. Finished setting, press "Up or Down button" to select "Start" and then press "Enter button" to start.

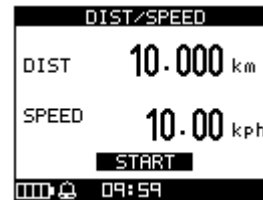

3. Your training performance will shown on the device including REST DISTANCE, CURRENT PROGRESS(BEHINE OR AHEAD), YOURSELF PERFORMANCE AND TRAINER PERFORMANCE.



4. Press Enter button for 2seconds will exit this training . REALLY WANT TO STOP ?.



7.1.3 SPEED / TIME

[MAIN MENU] > [GYM] > [TRAINER] > [SPEED / TIME]

Set speed 10km/hr and time 00:05:00 means you have to keep 10km/hr to training till 1 hour.

1. You could change SPEED / TIME to set up your goal.



2. Finished setting, press "Up or Down button" to select "Start" and then press "Enter button" to start.



3. Your training performance will shown on the device including REST DISTANCE, CURRENT PROGRESS(BEHINE OR AHEAD), YOURSELF PERFORMANCE AND TRAINER PERFORMANCE.



4. Press Enter button for 2seconds will exit this training . REALLY WANT TO STOP ?.



7.1.4 PACE / DIST

[MAIN MENU] > [GYM] > [TRAINER]>[PACE/DIST]

Set speed 10km/hr and time 01:00:00 means you have to keep 10km/hr to training till 1 hour.

1. You could change SPEED / TIME to set up your goal.



2. Finished setting, press "Up or Down button" to select "Start" and then press "Enter button" to start.



3. Your training performance will shown on the device including REST DISTANCE, CURRENT PROGRESS(BEHINE OR AHEAD), YOURSELF PERFORMANCE AND TRAINER PERFORMANCE.



4. Press Enter button for 2seconds will exit this training . REALLY WANT TO STOP ?.



7.1.5 YOURSELF

[MAIN MENU] >[GYM]>[TRAINER]>[YOURSELF]

1. Trainer can select the pervious records as your competition partner during the race.

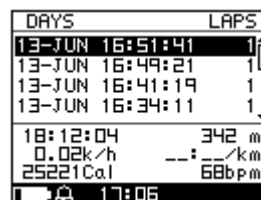

2. The setting is according to the specified record.



3. Your training performance will shown on the device including REST DISTANCE, CURRENT PROGRESS(BEHINE OR AHEAD), YOURSELF PERFORMANCE AND TRAINER PERFORMANCE.



4. Press Enter button for 2seconds will exit this training . REALLY WANT TO STOP ?.



7.2 MULTISPORT

[MAIN MENU] > [GYM] > [TRAINER] > [MULTISPORT]

you could set running, biking, swimming training time/ speed on GH-625XT to train yourself.

Multi-Sport provides you professional training such as triathlon to string a whole record

1. Set up the training sequence and custom page individually.

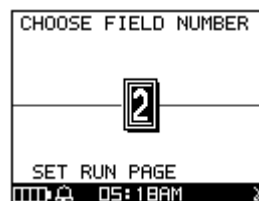

2. Press "start multisport"



3. When you press "UP" button for 3 seconds, the training item will transit to next item and keep record your training data.

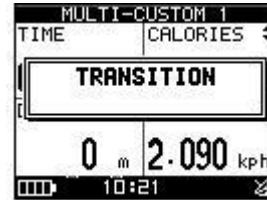

4. The message will show on display and let you know the next item is going to keep recording.



5. Till you going to stop training, press "OK" button and display shows "PAUSE"

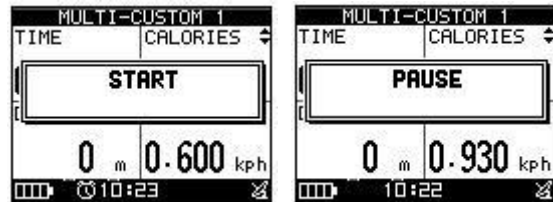

6. Rest training data and save ? Press "YES"



7. All training data back to zero for going next new training data.



7.3 INTERVAL TRAIN

7.3.1 CREATE WORKOUT

1. Several activities like hockey or soccer need this kind particular training. To select CREATE WORKOUT to create a new workout.



2. To insert interested session into the program.



3. The training program will be built up with the sequent training sessions.



4. Once finished, select CONFIRM to save and start training.



5. The training program will be listed in LIST ALL for the further training.



7.3.2 LIST ALL

1. The list of workout data you have created



2. Press "START" to start the training



3. You may press "LAP" button to switch to next training item directly.



4. When the all sessions finished, system will pop message to ask to save training data.



7.3.3 DELTE ALL

You can delete all the training data stored in the device.



8. NAVIGATION

8.1 ADD MAP MODE / REMOVE MAP MODE

[MAIN MENU] > [NAVIGATION] > [ADD/REMOVE MAP MODE]

You can use this feature to display or not display the map mode. However, while the Map Mode is off, and you execute "Return to start" or "GOTO" a waypoint, the Map Mode will be turn on again.



If Map mode was enable, Map information will appear.

8.2 ROUTES

8.2.1 LIST ALL

[MAIN MENU] > [NAVIGATION] > [ROUTES] > [LIST ALL]

1. Get routes data from software "Training Gym Pro"
2. The map information of routes will show on the display for your guiding. Select "FOLLOW" to get training. It will guide you automatically. You may press "ENTER" or "ESC" to go next or last waypoint
3. Chose "Backward" or "Forward" to start your route.
4. DO YOU RECORD RUNNING DATA ? Press YES
5. The screen will show map. Press "Page button" display the distance and time for you to reach destination on the right part of screen. The direction of destination waypoint is shown by the arrow sign of the compass.

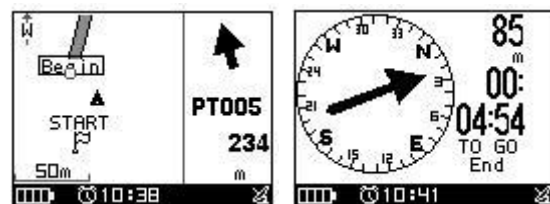
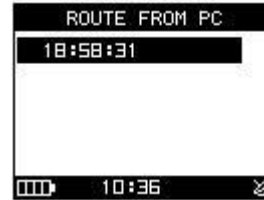

NOTE: Please use Training Gym Pro Ver 1.6.7 or above to transfer ROUTE to device.

8.2.2 DELETE ALL

[MAIN MENU] > [NAVIGATION] > [ROUTES] > [DELETE ALL]

1. A confirmation dialog box will appear.
2. Use Up and Down button to highlight "YES" and press OK.
3. All routes data in memory will be deleted.



8.2.3 ROUTES SETTING

[MAIN MENU] > [NAVIGATION] > [ROUTES] > [ROUTE SETTING]

1. SWITCH DISTANCE: The R radius of coverage setting, if the coverage is cover specified point, system will automatically guide the next point.
2. AUTO JUMP: If trainer offset the way to point B, system will upon the distance to point B to re-direct to point C.

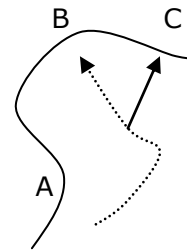
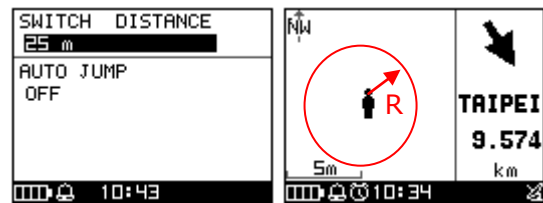

NOTE: AUTO JUMP configuration also will affect TRACK BACK application.

8.3 SAVE WAYPOINT

[MAIN MENU] > [NAVIGATION] > [SAVE WAYPOINT]

1. You can save the current position. If the GPS position is fixed, it shows the longitude, latitude and elevation on the screen.
2. Use Up and Down button to scroll to the item you wish to modify and then use the "Enter button" to select and confirm.



- When you finish the modification, input a “enter sign” character or press the “Esc /Lap button” to exit.
- Move highlight to "CONFIRM?" and press “Enter button”. The location data will be stored in the memory

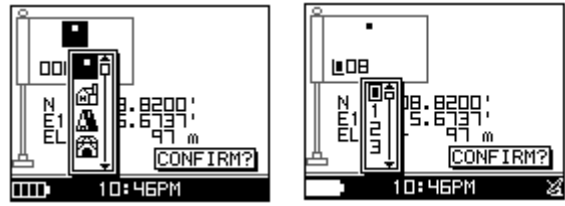

8.4 FIND WAYPOINT

8.4.1 LIST ALL

[MAIN MENU] > [NAVIGATION] > [FIND WAYPOINT] > [LIST ALL]

- Use Up and Down button to scroll to the Waypoint you wish to go to and press “Enter button”.
- Highlight "GOTO?" item and press “Enter button”.
- You will see your current position and destination point on the screen, and those nearby waypoints are also displayed.
- Press “Page button” display the distance and time for you to reach destination on the right part of screen. The direction of destination waypoint is shown by the arrow sign of the compass.

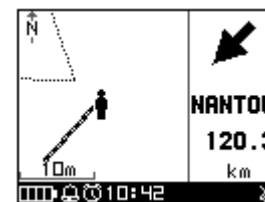
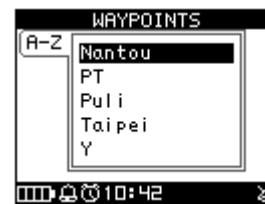

8.4.2 DELETE ALL

[MAIN MENU] > [NAVIGATION] > [FIND WAYPOINT] > [DELETE ALL]

1. A confirmation dialog box will appear.
2. Use Up and Down button to highlight "YES" and press OK.
3. All waypoints in memory will be deleted.



8.5 RETURN TO START /STOP GOTO

[MAIN MENU] > [NAVIGATION] > [RETURN TO START / STOP GOTO]

1. You can use this feature to navigate you back to the start point of the latest saved training data.
2. The navigation screen is shown and you can follow the direction of arrow to go back to the start point.
3. If you want to stop the navigation, press [MAIN MENU] > [NAVIGATION] > [STOP GOTO].



9 CONNECT TO PC

[MAIN MENU] > [CONNECT TO PC]

The Exercise Studio allows you to setup the pause, alarm and sport type for GH-625.

You can transfer the training data from GH-625XT your PC.



10 CONFIGURATION

10.1 USER PROFILE

[MAIN MENU] > [CONFIGURATION] > [USER PROFILE]

1. You can input your personal information in the user profile.
2. The data fields include "username", "gender", "birth date", "weight" and "height".
3. The system will do the calories calculation base on the information you provide. Please input the correct value.

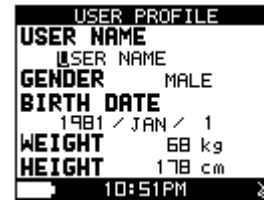

10.2 SET CUSTOM PAGE

[MAIN MENU] > [CONFIGURATION] > [SET CUSTOM PAGE]

1. Modify the screen field number.
2. There have five types of screen field could be choose for every page.
3. Select the function coefficient you want then press 'Enter button' to save setting.

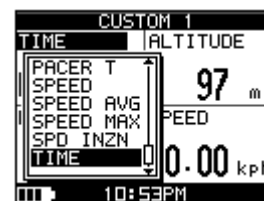
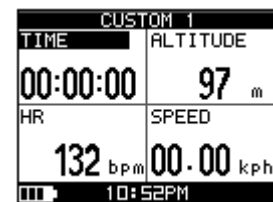
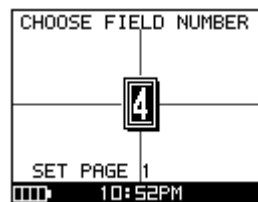
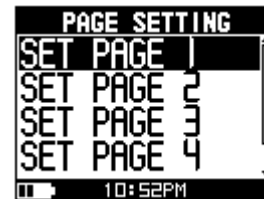

10.3 SET SYSTEM

[MAIN MENU] > [CONFIGURATION] > [SET SYSTEM]

BEEPER

You can set beeper on or off



TOD MODE

There are two selections could be enter to watch mode by 5. It means watch mode will be entered after 5minutes when system is stand by. OFF means always in operation mode.

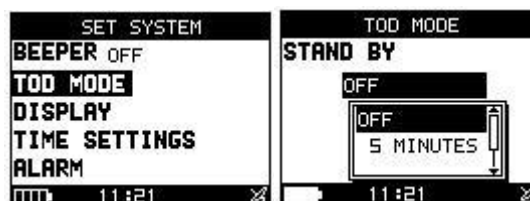

DISPLAY

- **Backlight**

Set the backlight to stay on or automatically turn off after a period of time once you press Power button to activate the backlight.



- **Language**

There are 5 different languages of User Interface, including "English", "Spanish", "Italian", "French" and "Germany".



- **Contrast**

The display brightness can be adjusted by this way.



TIME SETTINGS

- **Time Format**

1. Use Up and Down button to scroll to the item and press OK to modify it.
2. You can set the time to display in the 12 Hour or 24 hour format.



- **Time Zone**

1. Use Up and Down button to scroll to the item and press OK to modify it.
2. You can select your local time zone.



- **Daylight Saving**

1. Use Up and Down button to scroll to the item and press OK to modify it.
2. You can select the daylight saving if necessary, and then system will display the correct time for you.



ALARM

You can set the alarm clock for WEEKEND, WEEKDAY, DAILY...or OFF. And then set up the time you want clock to ring you.

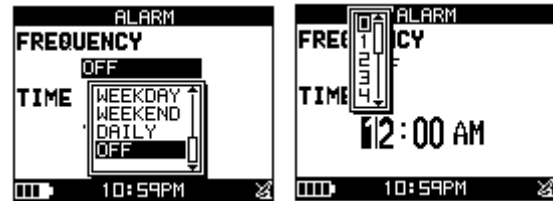

10.4 UNITS

[MAIN MENU] > [CONFIGURATION] > [UNITS]

1. The measurement unit can be set as "statute" or "metric".
2. The speed unit can be set as Pace (min/m, min/K) or Speed (mph, kph).

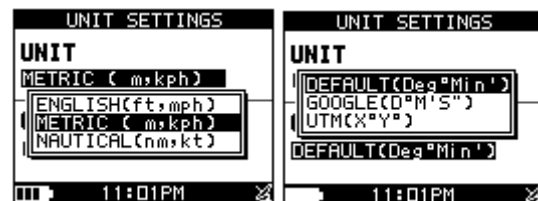

10.5 CARDIO SET

[MAIN MENU] > [CONFIGURATION] > [CARDIO SETTING]

1. You can select USE MAX or CUSTOM to set up your heart rate zone or guiding Max heart is calculated by 220-age.

2. CUSTOM means you can set your own heart rate zone by yourself. You can select any percentage or bmp for viewing.

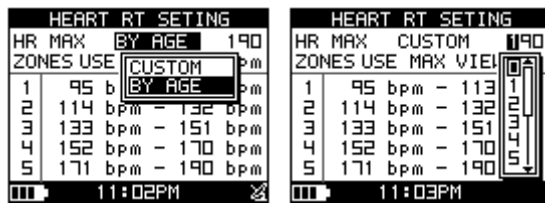

3. CUSTOM means you can set your own heart rate zone by yourself.

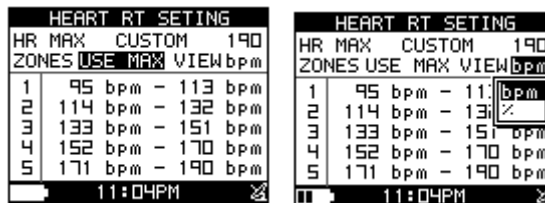

10.5 GPS SETTINGS

[MAIN MENU] > [CONFIGURATION] > [GPS SETTINGS]

WAAS/EGNOS

You can turn on/off the "WAAS/EGNOS" feature.

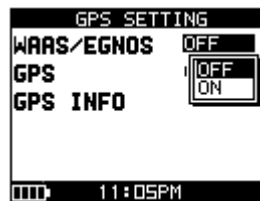

GPS

The GPS function can be turned off for saving battery power. If the battery power is pretty low, the system will also ask you if you want to turn off the GPS function.

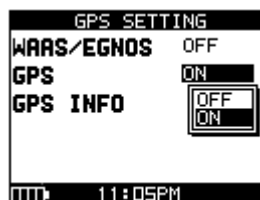

GPS INFO

Here you can see the positioning status of how many satellite signals are obtained and the signal strength.

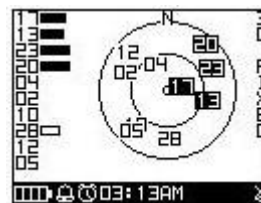

10.6 MAP MODE SET

DIRECTH TO NORTH: In Map Mode, system always orients to North on twelve o'clock direction.

BIRD EYE VIEW: System always changes its orientation upon practical direction.



10.7 FACTORY RESET

[MAIN MENU] > [CONFIGURATION] > [FACTORY RESET]

This feature allows you to restore the GH-625XT back to factory default status. In another words, the training data, waypoint, and user profile will be erased.



10.8 SYSTEM UPGRADE

[MAIN MENU] > [CONFIGURATION] > [SYSTEM UPGRADE]

1. Allow you to upgrade the firmware of GH-625XT.
2. If you want to cancel the upgrade process, press Power + ESC button at the same time.

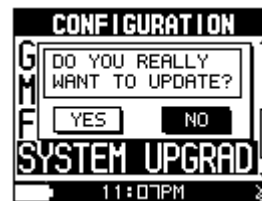

10.9 ABOUT PRODUCT

[MAIN MENU] > [CONFIGURATION] > [ABOUT PRODUCT]

Display the firmware version information.



11. Glossary

Activity	Relates to data being transmitted from GH-625. Activity is a history or log of events. Activity data includes time or distance updates.
Waypoint	Waypoints are sets of coordinates that identify a point in physical space. For the purposes of terrestrial navigation, these coordinates usually include longitude and latitude, and sometimes altitude (particularly for air navigation).
Trackpoint	The current moving trace.
Navigation	The act of determining the course or heading of movement.
2D Operating Mode	A "two-dimensional GPS position fix" includes only horizontal coordinates. It requires a minimum of three visible satellites.
3D Operating Mode	A "three-dimensional GPS position fix" includes horizontal coordinates, plus elevation. It requires a minimum of four visible satellites.
Weak Signal	GPS signal is weak (GPS is fixing).
Receiving	Can't find GPS (GPS turned off or broken down).
WAAS/EGNOS	Wide Area Augmentation System / European Geostationary Navigation Overlay Service. These are two satellite-based systems that can be used to increase the accuracy of GPS position fixes.
IPX7	An IPX7 designation means the GPS case can withstand accidental immersion in one meter of water for up to 30 minutes.
GMT	Greenwich Mean Time (GMT) is a term originally referring to mean solar time at the Royal Observatory, Greenwich in England. It is now often used to refer to Coordinated Universal Time (UTC) when this is viewed as a time zone, although strictly UTC is an atomic time scale which only approximates GMT in the old sense. It is also used to refer to Universal Time (UT), which is the astronomical concept that directly replaced the original GMT.

12. Troubleshooting & FAQ

1. Why can't GH-625XT receive heart rate signal?

Solution:

- (1). Check if you correctly wear the heart rate monitor or not.
- (2). Turn on the Heart Rate Alert function in GH-625XT.
- (3). If it is still not working, check the battery of Heart Rate monitor.

2. Why does it show "PC com port error" when I download data?

Solution:

- (1). Please check if the USB driver is installed or not.
- (2). Connect GH-625XT to your PC with the USB cable.
- (3). Double click the "GS-Sport Training GYM Pro" icon from desktop to start the application.
- (4). From menu bar click "Settings" / "Configurations", and click "Scan COM Port" button. COM port will be automatically scanned.

FCC Notices

This device complies with part 15 of the FCC rules. Operation is subject to the following two conditions:

- (1) This device may not cause harmful interference, and
- (2) This device must accept any interference received, including interference that may cause undesired operation.

FCC RF Exposure requirements:

This device and its antenna(s) must not be co-located or operation in conjunction with any other antenna or transmitter.

NOTE: THE MANUFACTURER IS NOT RESPONSIBLE FOR ANY RADIO OR TV INTERFERENCE CAUSED BY UNAUTHORIZED MODIFICATIONS TO THIS EQUIPMENT. SUCH MODIFICATIONS COULD VOID THE USER'S AUTHORITY TO OPERATE THE EQUIPMENT.

CAUTION

**RISK OF EXPLOSION IF BATTERY IS REPLACED BY AN INCORRECT TYPE.
DISPOSE OF USED BATTERIES ACCORDING TO THE INSTRUCTIONS**