

GH5200 User Manual

V1.0



Table of contents

1	INTRODUCTION	7
1.1	ATTENTION.....	7
1.2	BRIEF DESCRIPTION.....	8
1.3	LEGAL NOTICE.....	8
1.4	ABOUT DOCUMENT.....	8
2	BASIC DESCRIPTION	11
2.1	PACKAGE CONTENTS.....	11
2.2	BASIC CHARACTERISTICS.....	11
2.3	TECHNICAL FEATURES.....	12
2.4	TECHNICAL INFORMATION ABOUT INTERNAL BATTERY.....	12
2.5	ELECTRICAL CHARACTERISTICS.....	13
3	CONNECTION	14
3.1	HOW TO INSERT SIM CARD AND CONNECT THE BATTERY INTO GH5200 DEVICE:.....	14
3.2	INSTALLING GH5200 DRIVERS.....	15
4	OPERATIONAL BASICS	17
4.1	OPERATIONAL PRINCIPLES.....	17
4.2	SLEEP MODES.....	17
4.2.1	<i>GPS Sleep mode</i>	17
4.2.2	<i>Deep Sleep mode</i>	17
4.2.3	<i>Online Deep Sleep mode</i>	18
4.2.4	<i>Ultra Deep Sleep mode</i>	18
4.3	FEATURES.....	18
4.3.1	<i>Alarm</i>	18
4.3.2	<i>ManDown</i>	19
4.3.3	<i>OverSpeeding</i>	19
4.3.4	<i>Movement Event</i>	19
4.4	VOICE CALL.....	19
4.5	TRACKING ON/OFF.....	20
4.6	BLUETOOTH.....	20
4.7	AUTO GEOFENCE.....	20
4.8	MANUAL GEOFENCE.....	20
4.9	USER INTERFACE.....	20
4.10	KEYBOARD.....	20
5	CONFIGURATION	20
5.1	CONFIGURATOR.....	20
5.1.1	<i>Main Buttons description:</i>	22
5.1.2	<i>Keyword SMS (GPRS) commands:</i>	22
5.1.3	<i>Keyword configuration with TCP</i>	22
5.2	STATUS INFO.....	23
5.3	SECURITY INFO.....	23
5.4	SYSTEM SETTINGS.....	24
5.5	GPRS.....	26
5.6	SMS/CALL SETTINGS.....	27
5.7	GSM OPERATORS, ROAMING, BLACKLIST OPERATOR LIST.....	28
5.8	DATA ACQUISITION MODE SETTINGS.....	30
5.9	FEATURES SETTINGS.....	34
5.9.1	<i>Alarm</i>	34
5.9.2	<i>Over Speeding</i>	35
5.9.3	<i>ManDown</i>	35
5.9.4	<i>Movement Event</i>	36
5.10	AUTOGEOFENCING SETTINGS.....	36

5.11	MANUAL GEOFENCE.....	37
5.12	BLUETOOTH.....	39
5.12.1	General functionality.....	39
5.12.2	How to connect Bluetooth Hands Free adapter to GH5200 device.....	40
5.12.2.1	Bluetooth settings configuration.....	40
5.12.2.2	Connecting Bluetooth Hands Free adapter.....	42
5.12.3	Logging the GH5200 device using your mobile phone.....	42
5.12.4	Device debug over Android smartphone.....	43
5.13	SMS EVENTS.....	45
5.14	SMS TEXT.....	46
5.15	I/O SETTINGS.....	47
5.15.1	Operand On Exit.....	48
5.15.2	Operand On Entrance.....	48
5.15.3	Operand On Both.....	48
5.15.4	Operand Monitoring.....	49
5.15.5	Operand On Hysteresis.....	49
5.15.6	Operand On Change.....	49
5.15.7	Operand On Delta Change.....	50
5.15.8	Avg const (Averaging parameter description).....	50
5.16	USER INTERFACE.....	51
5.17	KEYBOARD.....	55
6	SMS/GPRS COMMAND LIST.....	56
6.1	SMS/GPRS COMMAND LIST.....	56
6.1.1	getinfo.....	58
6.1.2	getver.....	59
6.1.3	getstatus.....	59
6.1.4	getgps.....	59
6.1.5	ggps.....	60
6.1.6	getparam.....	60
6.1.7	setparam.....	60
6.1.8	flush #,#,#,#,#,#.....	60
6.1.9	countrecs.....	61
6.1.10	deleterecords.....	61
6.1.11	battery.....	61
6.1.12	btgetlist #.....	61
6.1.13	setkey # #.....	62
6.1.14	delkey # #.....	62
6.1.15	bbread #.....	62
6.1.16	bbinfo #.....	62
6.1.17	sdformat.....	62
7	PARAMETER LIST.....	63
7.1	SYSTEM PARAMETERS.....	63
7.1.1	Sleep Mode (ID=102).....	63
7.1.2	Sleep timeout (ID=103).....	63
7.1.3	Static Navigation (ID=106).....	63
7.1.4	Saving/Sending without time synchronization (ID=107).....	63
7.1.5	GNSS Source (ID=109).....	63
7.1.6	Synchronization settings (ID=900).....	64
7.1.7	NTP Resync (ID=901).....	64
7.1.8	NTP server 1 (ID=902).....	64
7.1.9	NTP server 2 (ID=903).....	64
7.2	GPRS PARAMETERS.....	65
7.2.1	Sorting (ID=1002).....	65
7.2.2	Open Link Timeout (ID=1000).....	65
7.2.3	Server Response Timeout (ID=1001).....	65
7.2.4	SIM GPRS content activation (ID=2000).....	65

7.2.5	<i>SIM APN Name (ID=2001)</i>	66
7.2.6	<i>SIM APN Username (ID=2002)</i>	66
7.2.7	<i>SIM APN Password (ID=2003)</i>	66
7.2.8	<i>Domain (ID=2004)</i>	66
7.2.9	<i>Target Server Port (ID=2005)</i>	66
7.2.10	<i>Protocol (ID=2006)</i>	67
7.2.11	<i>Backup Server Domain (ID=2007)</i>	67
7.2.12	<i>Backup Server Port (ID=2008)</i>	67
7.2.13	<i>Backup Server Protocol (ID=2009)</i>	67
7.2.14	<i>Backup Server Mode (ID=2010)</i>	67
7.2.15	<i>FOTA WEB status (ID=13003)</i>	67
7.2.16	<i>FOTA WEB Domain (ID=13000)</i>	68
7.2.17	<i>FOTA WEB port (ID=13001)</i>	68
7.2.18	<i>FOTA WEB Period (min) (ID=13002)</i>	68
7.3	SMS/CALL SETTINGS	68
7.3.1	<i>SMS data sending settings (ID=3000)</i>	68
7.3.2	<i>Data send number (ID=3001)</i>	68
7.3.3	<i>Authorized phone numbers (ID=4000-4199)</i>	69
7.3.4	<i>GSM Predefined Numbers (ID=6000-6009)</i>	69
7.3.5	<i>SMS Login (ID=3003)</i>	69
7.3.6	<i>SMS Password (ID=3004)</i>	69
7.3.7	<i>Incoming call action (ID=3005)</i>	69
7.3.8	<i>SMS Event Time Zone (ID=3006)</i>	70
7.3.9	<i>Detect Number Type By Plus Symbol (ID=4999)</i>	70
7.4	GSM OPERATORS	70
7.4.1	<i>SIM Roaming Operator List (ID=5000-5049)</i>	70
7.4.2	<i>Black List (ID=5500-5549)</i>	70
7.5	DATA ACQUISITION MODES PARAMETERS	71
7.5.1	<i>Home Network GSM operator code "Vehicle on STOP" parameters</i>	71
7.5.1.1	<i>Min Period (ID=10000)</i>	71
7.5.1.2	<i>Min Saved Records (ID=10004)</i>	71
7.5.1.3	<i>Send Period (ID=10005)</i>	71
7.5.2	<i>Home Network GSM operator code "Vehicle MOVING" parameters</i>	71
7.5.2.1	<i>Min Period (ID=10050)</i>	71
7.5.2.2	<i>Min Distance (ID=10051)</i>	71
7.5.2.3	<i>Min Angle (ID=10052)</i>	72
7.5.2.4	<i>Min Speed Delta (ID=10053)</i>	72
7.5.2.5	<i>Min Saved Records (ID=10054)</i>	72
7.5.2.6	<i>Send Period (ID=10055)</i>	72
7.5.3	<i>Roaming Network GSM operator code "Vehicle on STOP" parameters</i>	73
7.5.3.1	<i>Min Period (ID=10100)</i>	73
7.5.3.2	<i>Min Saved Records (ID=10104)</i>	73
7.5.3.3	<i>Send Period (ID=10105)</i>	73
7.5.4	<i>Roaming Network GSM operator code "Vehicle MOVING" parameters</i>	73
7.5.4.1	<i>Min Period (ID=10150)</i>	73
7.5.4.2	<i>Min Distance (ID=10151)</i>	74
7.5.4.3	<i>Min Angle (ID=10152)</i>	74
7.5.4.4	<i>Min Speed Delta (ID=10153)</i>	74
7.5.4.5	<i>Min Saved Records (ID=10154)</i>	74
7.5.4.6	<i>Send Period (ID=10155)</i>	75
7.5.5	<i>Unknown Network GSM operator code "Vehicle on STOP" parameters</i>	75
7.5.5.1	<i>Min Period (ID=10200)</i>	75
7.5.5.2	<i>Min Saved Records (ID=10204)</i>	75
7.5.5.3	<i>Send Period (ID=10205)</i>	75
7.5.6	<i>Unknown Network GSM operator code "Vehicle MOVING" parameters</i>	75
7.5.6.1	<i>Min Period (ID=10250)</i>	75
7.5.6.2	<i>Min Distance (ID=10251)</i>	76
7.5.6.3	<i>Min Angle (ID=10252)</i>	76
7.5.6.4	<i>Min Speed (ID=10253)</i>	76
7.5.6.5	<i>Min Saved Records (ID=10254)</i>	77

7.5.6.6	Send Period (ID=10255).....	77
7.6	FEATURES PARAMETERS	77
7.6.1	<i>Alarm</i>	77
7.6.1.1	Scenario Settings (ID=11710).....	77
7.6.1.2	Send SMS To (ID=7245)	77
7.6.1.3	SMS Text (ID=8245)	77
7.6.1.4	Call Settings (ID=11711)	78
7.6.1.5	Call to (ID=11712)	78
7.6.2	<i>Overspeeding scenario parameters</i>	78
7.6.2.1	Overspeeding priority (ID=11100)	78
7.6.2.2	Max Speed (ID=11104)	78
7.6.2.3	Overspeeding Send SMS To (ID=7032)	78
7.6.2.4	Overspeeding SMS Text (ID=8032)	79
7.6.3	<i>ManDown scenario parameters</i>	79
7.6.3.1	Scenario Settings (ID=12100).....	79
7.6.3.2	Position (ID=12100)	79
7.6.3.3	Angle (ID=12102)	79
7.6.3.4	Timeout (ID=12103).....	79
7.6.3.5	Send SMS To (ID=7222)	79
7.6.3.6	SMS Text (ID=8222)	79
7.6.3.7	Call Settings (ID=12104)	80
7.6.3.8	Call to (ID=12105)	80
7.7	AUTOGEOFENCING SCENARIO PARAMETERS	80
7.7.1	<i>AutoGeofencing priority (ID=20000)</i>	80
7.7.2	<i>Eventual Records (ID=20002)</i>	80
7.7.3	<i>AutoGeofence event generating (ID=20001)</i>	81
7.7.4	<i>Radius (ID=20004)</i>	81
7.7.5	<i>AutoGeofence Send SMS to (ID=7030)</i>	81
7.7.6	<i>SMS Text (ID=8030)</i>	81
7.7.7	<i>Call Settings (ID=12104)</i>	82
7.7.8	<i>Call to (ID=12105)</i>	82
7.8	MANUAL GEOFENCE.....	82
7.8.1	<i>First Geozone parameters</i>	82
7.8.1.1	#1 Geozone Manual Geofencing priority (ID=20100):.....	82
7.8.1.2	#1 Geozone Manual Geofence event generating (ID=20101)	83
7.8.1.3	#1 Geozone Eventual Records (ID=20102)	83
7.8.1.4	#1 Geozone Frame border (ID=20103)	83
7.8.1.5	#1 Geozone Shape type (ID=20104)	84
7.8.1.6	#1 Geozone Radius (ID=20105).....	84
7.8.1.7	#1 Geozone X1 (ID=20106)	85
7.8.1.8	#1 Geozone Y1 (ID=20107)	85
7.8.2	<i>Other Geozones</i>	86
7.8.2.1	Send SMS to #1-5 Geozone (ID=7025-7029), #6-50 Geozone (ID=7071-7115).....	86
7.8.2.2	SMS Text #1-5 Geozone (ID=8025-8029), #6-50 Geozone (ID=8071-8115).....	86
7.9	USER INTERFACE.....	87
7.9.1	<i>Indication Scenario (12500)</i>	87
7.9.2	<i>Sleep Config (12501)</i>	87
7.9.3	<i>Led (12502)</i>	87
7.9.4	<i>Vibration (12503)</i>	87
7.9.5	<i>Period (12504)</i>	87
7.9.6	<i>On (ms) (12505)</i>	87
7.9.7	<i>Off (ms) (12506)</i>	88
7.9.8	<i>Repeat (12507)</i>	88
7.10	KEYBOARD.....	91
7.11	ACTIONS	93
7.11.1	<i>SMS Action</i>	93
7.11.1.1	SMS Send to (7249)	93
7.11.1.2	SMS Text (8249).....	93
7.11.2	<i>Call Action</i>	93
7.11.2.1	Call to (13010)	93
7.12	BLUETOOTH.....	93

7.12.1.1	BT Radio (ID=800)	93
7.12.1.2	Local name (ID 801)	93
7.12.1.3	Local PIN (ID=802)	94
7.12.1.4	Security mode (ID=803)	94
7.12.1.5	External MAC (ID=804)	94
7.12.1.6	External name (ID=805)	95
7.12.1.7	External PIN (ID=806)	95
7.12.1.8	Connection mode (ID=807)	95
7.12.1.9	Authorized devices MAC list (ID=830 - 834)	96
7.13	I/O PARAMETERS	96
7.13.1	I/O#1 property parameter priority (ID=50010)	96
7.13.2	I/O#1 operand (ID=50011)	96
7.13.3	I/O#1 High level (ID=50012)	97
7.13.4	I/O#1 Low level (ID=50013)	97
7.13.5	I/O#1 Event only (ID=50014)	97
7.13.6	I/O#1 averaging length (ID=50015)	98
7.13.7	I/O#1 send SMS (ID=7001)	98
7.13.8	I/O#1 SMS text (ID=8001)	98
7.13.9	I/O elements parameters and types	99
8	DEBUG MODE	104
9	CHANGE LOG	105

1 INTRODUCTION

1.1 Attention



Operate the device in suitable conditions

Do not use the device where mobile connectivity is forbidden.



Road safety first

Comply with local traffic laws, always hold your hands on a steering wheel when using a device. Your safety is of utmost importance when you drive.



Interference

All wireless devices are sensitive to electromagnetic interference, as a result wireless devices affect the performance of each other.



Limit the use of device in hospitals

Please follow all restrictions. Turn off the device in the vicinity of medical devices when required.



Limit the use of device in vehicles

Please follow all restrictions. Wireless devices can interfere with other electronic equipment in vehicles.



Be cautious near flammable materials and liquids



Charging precautions

SELV LPS chargers, personal computers or laptops that device will be connected to must comply with the requirements of IEC 60950:2005 standard.



Use only original batteries

Using uncertified manufacturer or different type batteries may cause an explosion.



Use batteries safely

Protect batteries from moisture. Place them in a cool and dry place when storing. Avoid extensive operation at high temperatures. Do not attempt charging battery directly from the electrical mains. All utilised batteries shall comply with IEC 62133.



Power supplies

Power supply circuits used to charge the device connection must have safeguards, which prevent power leakage, short circuits or incorrect electrical grounding. Any used switches ought to be installed in a readily accessible location. Power must be uninterrupted and the distance between the contacts must be 3 mm or larger.



Remove device safely

Device must be disconnected from computer or charger by unplugging the magnetic USB cable from the device.



Other

In order to prevent device from mechanical damage it is advisable to transport it in a shock-resistant packaging. If device stopped working properly regardless of the settings only a qualified specialist can help. It is recommended to contact your local seller or your UAB Teltonika manager in such case.

1.2 Brief description

GH5200 is a handheld tracking device with built-in functions and characteristics of a mobile phone. This device is intended for the surveillance and protection of people, cargo and valuables. GNSS receiver is able to identify current location and send it to an operations center or a person. In case of an emergency the device can activate the alarm function or make a voice call. Device is able to execute various tasks through GSM network and GNSS system. Easy installation, operation and user friendly design will help perform the user's desired tasks easier.

1.3 Legal Notice

Copyright © 2019 Teltonika. All rights reserved. Reproduction, transfer, distribution or storage of part or all of the contents in this document in any form without the prior written permission of Teltonika is prohibited.

Other products and company names mentioned here may be trademarks or trade names of their respective owners.

The manufacturer reserves the right to make changes and/or improvements at any time in design, functionality, parameters and electrical characteristics without any prior notice and without incurring obligations.

1.4 About document

This document contains information about the architecture, possibilities, mechanical characteristics, and configuration of the GH5200 device.

Acronyms and terms used in this document:

- *AC/DC* – Alternating Current/Direct Current
- *ACC* – Accessories
- *AVL* - Automatic vehicle location: means for automatically determining and transmitting the geographic location of a vehicle.
- *AVL packet*: Data packet which is being sent to the server during data transmission.
- *APN* - Access Point Name: the name of a gateway between 3GPP mobile network and Internet or another computer network.
- *CAN* - Controller Area Network: a vehicle bus standard designed to allow microcontrollers and devices to communicate with each other in applications without a host computer.
- *CNG* - Compressed Natural Gas: methane stored at high pressure.
- *COM port* - serial communication interface that is used to transfer information to/from devices such as modems, terminals and various peripherals.
- *DTC* - Diagnostic Trouble Code
- *ESP* - Electronic Stability Program: is a technology that improves a vehicle's stability by detecting and reducing loss of traction (skidding).
- *ETA* - Estimated Time of Arrival
- *FAP* - Particulate Filter
- *FOTA* - Firmware-Over-The-Air

- *GNSS* – Global Navigation Satellite System: a system with global coverage that uses satellites to provide autonomous geo-spatial positioning.
- *GPS* – Global Positioning System: a worldwide satellite navigational system formed by 24 satellites orbiting the earth and their corresponding receivers on the earth.
- *GPRS* – General Packet Radio Service: a standard for wireless communications which runs at speeds up to 115 kilobits per second.
- *GSM* – Global System for Mobile Communications: one of the leading digital cellular systems. GSM uses narrowband TDMA, which allows eight simultaneous calls on the same radio frequency.
- *I/O* – Input/Output
- *ICCID* - Integrated Circuit Card Identifier: a unique serial number that is stored on the SIM card.
- *IMEI* - International Mobile Equipment Identity: is a unique number that is used to identify 3GPP mobile phones.
- *LED* - Light Emitting Diode
- *MAC* – Media Access Control. Hardware address which uniquely identifies each node of the network. In IEEE 802 networks, the Data Link Control (DCL) layer of the PSO Reference Model is divided into two sub-layers: the Logical Link Control (LLC) layer and the Media Access Control layer. The MAC layer interfaces directly with the network medium. Consequently, each different type of network medium requires a different MAC layer.
- *MAF* - Mass Airflow Sensor: a device used to measure the mass flow rate of air entering a fuel-injected internal combustion engine.
- *NITZ* - Network Identity and Time Zone: a mechanism for provisioning local time and date, time zone and DST offset, as well as network provider identity information, to mobile devices via a wireless network.
- *NMEA*: a data specification for communication between electronics such as echo sounder, sonars, anemometer, gyrocompass, autopilot, GPS receivers.
- *NTP* - Network Time Protocol: networking protocol for clock synchronization between computer systems over packet-switched, variable-latency data networks.
- *OBD* - On-board Diagnostics: a vehicle's self-diagnostic and reporting capability, which gives access to the status of the various vehicle subsystems.
- *PC* – Personal Computer
- *PCB* - Printed Circuit Board
- *PIN* - Personal Identification Number
- *RFID* - Radio-Frequency Identification: a method that uses electromagnetic fields to automatically identify and track tags attached to objects.
- *RPM* - Engine Revolutions Per Minute
- *RTC* - Real-Time Clock
- *SELV* - Safety Extra Low Voltage: an electrical system in which the voltage cannot exceed 50 VAC or 120 VDC under normal conditions, and under single-fault conditions, including earth faults in other circuits.
- *SMS* – Short Message Service: the transmission of short text messages to and from a mobile phone, fax machine and/or IP address.
- *SIM* - Subscriber Identification Module: an integrated circuit card that is intended to securely store the information which is used to identify and authenticate subscribers on mobile telephony devices.
- *TCP* – Transmission Control Protocol – one of the main protocols in TCP/IP networks. Whereas the IP protocol deals only with packets, TCP enables two hosts to establish a

connection and exchange streams of data. TCP guarantees delivery of data and also guarantees that packets will be delivered in the same order in which they were sent.

- *TMO* - Timeout
- *UDP* – User Datagram Protocol – a connectionless protocol that, like TCP, runs on top of IP networks. Provides very few error recovery services, offering instead a direct way to send and receive datagrams over IP network.
- *Record* – AVL data stored in FMB memory. AVL data contains GNSS and I/O information.

2 BASIC DESCRIPTION

GH5200 is an AUTONOMOUS personal tracker with GNSS, GSM and Bluetooth connectivity, device has high quality voice communication feature and modern slim design.

The tracker is designed for Lone Worker protection. Everyone who performs activity without close or direct supervision of others: healthcare visitors, maintenance workers, self-employed or working out of standard work hours employees.

2.1 Package contents

The GH5200 device is supplied to the customer in a cardboard box containing all the equipment that is necessary for operation. The package contains:

- GH5200 device;
- 3.7 V 1050 mAh rechargeable Li-ion battery;
- Micro USB cable;
- Screw driver.

2.2 Basic characteristics

GSM / GPRS / GNSS features:

- Teltonika TM2500 quad band module (GSM 850 / 900 / 1800 / 1900 MHz);
- GPRS class 12 (Up to 240 kbps);
- SMS (text, data);
- Integrated GNSS receiver;
- Up to -165 dBm GNSS receiver sensitivity.

Hardware features:

- Built-in accelerometer;
- Panic button;
- Built-in Bluetooth 3.0 and 4.0);
- Internal High Gain GNSS antenna;
- Internal High Gain GSM antenna;
- 1050 mAh Li-ion rechargeable 3.7 V battery.
- Slim casing;
- Magnetic USB cable.

Firmware features:

- Fast position fix;
- Two way voice communication;
- Man-down detection;
- 50 Manual Geofence zones;
- Auto Geofencing;
- Action on call feature;
- Configurable 3 LED status indication;
- Authorized numbers;
- Time synchronization over NTP and NITZ;
- Real time tracking;
- Smart data acquisition based on:

- Time;
- Speed;
- Angle;
- Distance;
- Movement or any other I/O event;
- Sending acquired data via GPRS;
- GPRS and SMS I/O events;
- Configurable using Secured SMS Commands.

2.3 Technical features

Part name	Physical specification
LED	3 status LEDs
USB	Micro USB socket
GNSS	Internal GNSS antenna
GSM	Internal GSM antenna
Microphone and speaker	Internal microphone and speaker
BUTTON	5 configurable buttons

Technical details
<p>Energy consumption¹:</p> <p>GPRS: average 52.31 mA; Nominal: average 45.10 mA; GNSS Sleep: average 10.12 mA; Deep Sleep: average 3.02 mA; Online Deep Sleep: average 3.78 mA; Ultra Deep Sleep: average 1.82 mA.</p> <p>Battery charge current: --- average 733 mA;</p> <p>Operation temperature: -25 °C .. +65 °C</p> <p>Storage temperature: -40 °C .. +70 °C</p> <p>Storage relative humidity: 5 .. 95 % (no condensation)</p>

2.4 Technical Information about internal battery

Table 1. Li-ion rechargeable battery, 3.7 V, 1050 mAh.

Internal back-up battery	Battery voltage V	Nominal capacity (mAh)	Power (Wh)	Charging temperature °C
Li-ion rechargeable battery	3.70	1050	3.885	0 – 45

¹

Energy consumption has been tested by running GH5200 on battery (4.2 V).



CAUTION: RISK OF EXPLOSION IF BATTERY IS REPLACED BY AN INCORRECT TYPE. DISPOSE OF USED BATTERIES ACCORDING TO THE INSTRUCTIONS.

Battery Disposal instructions:



Battery should not be disposed of into general household waste. Bring damaged or worn-out batteries to your local recycling center or dispose them into a battery recycle bin commonly found in supermarkets.

Warranty: batteries are covered by 6 months warranty support.

2.5 Electrical characteristics

Table 2. GH5200 electrical characteristics

Characteristic description	Value			
	Min.	Typ.	Max.	Unit
Supply Voltage:				
In recommended operating conditions	4.5	5.0	5.5	V DC

3 CONNECTION

3.1 How to insert SIM card and connect the battery into GH5200 device:

① Remove GH5200 cover.

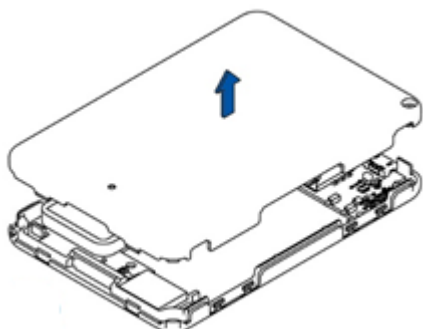

② Insert Micro SIM card as shown. Battery has to be disconnected at this point.

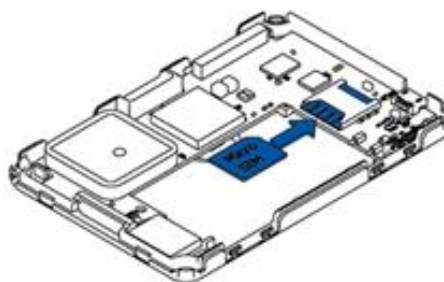

③ Insert the battery.

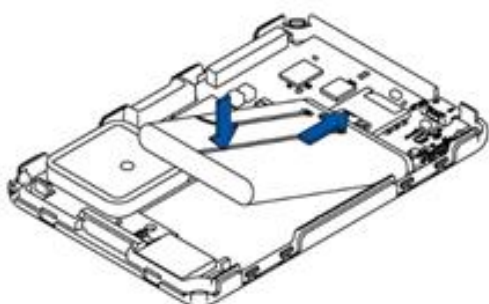

④ Reattach the cover and tighten the screw

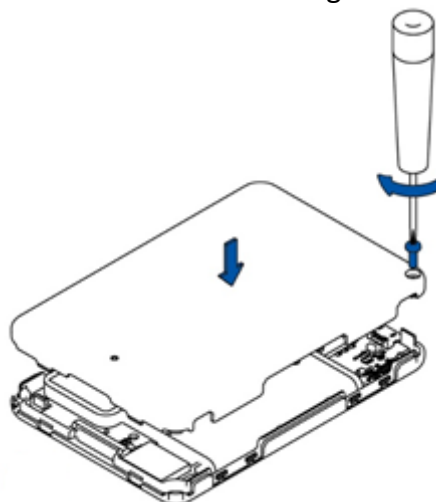

Note: SIM card insertion/removal must be performed when GH5200 device is powered off – with external voltage and battery disconnected. Otherwise SIM card may be damaged.

3.2 Installing GH5200 drivers

Table 3. Software requirements:

Operating system	Version	MS .NET Framework version
Windows XP with SP3 or later	32 bit and 64 bit	<p>MS .NET Framework 4 https://www.microsoft.com/en-US/Download/confirmation.aspx?id=17718 http://avl1.teltonika.lt/downloads/software/Framework/.NET%20Framework%204/dotNetFx40_Full_x86_x64.exe</p> <p>With MS .NET Framework 4 update KB2468871-v2 update https://www.microsoft.com/en-us/download/details.aspx?id=3556 http://avl1.teltonika.lt/downloads/software/Framework/.NET%20Framework%204%20update%20KB2468871-v2/ NDP40-KB2468871-v2-x86.exe NDP40-KB2468871-v2-x64.exe or NDP40-KB2468871-v2-IA64.exe</p>
Windows Vista Windows 7 Windows 8.1 Windows 10	32 bit and 64 bit	<p>MS .NET Framework 4.6.2 https://www.microsoft.com/en-us/download/confirmation.aspx?id=53344 http://avl1.teltonika.lt/downloads/software/Framework/.NET%20Framework%204.6.2/NDP462-KB3151800-x86-x64-AllOS-ENU.exe</p>

Drivers:

Please download COM Port drivers from Teltonika website:

http://avl1.teltonika.lt/downloads/FMB1/MS_USB_ComPort_Driver_exe_v1.1032.3.zip

Installing drivers:

Extract and run MS_USB_ComPort_Driver_exe_v1.1032.3. This driver is used to control GH5200 device connected to the computer. Click **Next** in driver installation window:

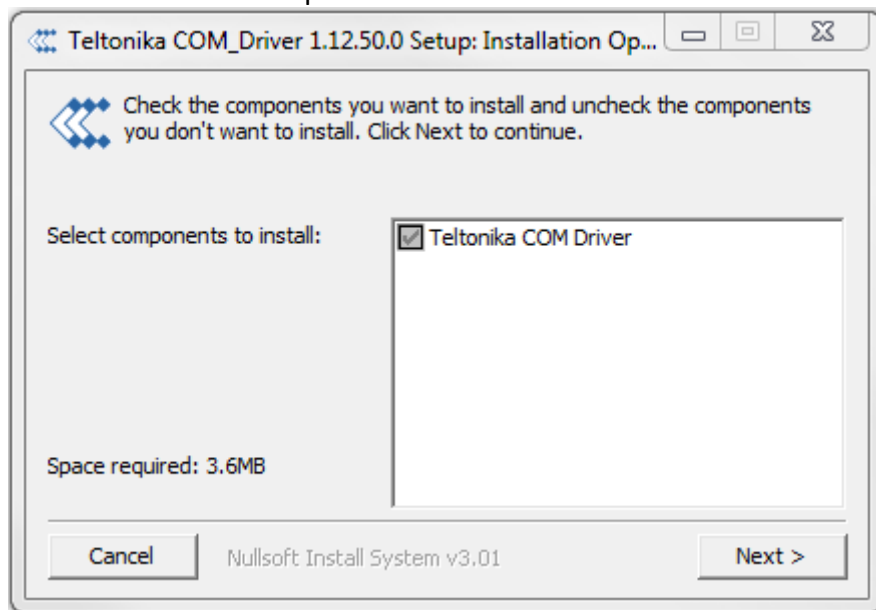

Figure 2 Driver installation window 1

This will launch device driver installation wizard. In the following window click **Install**:

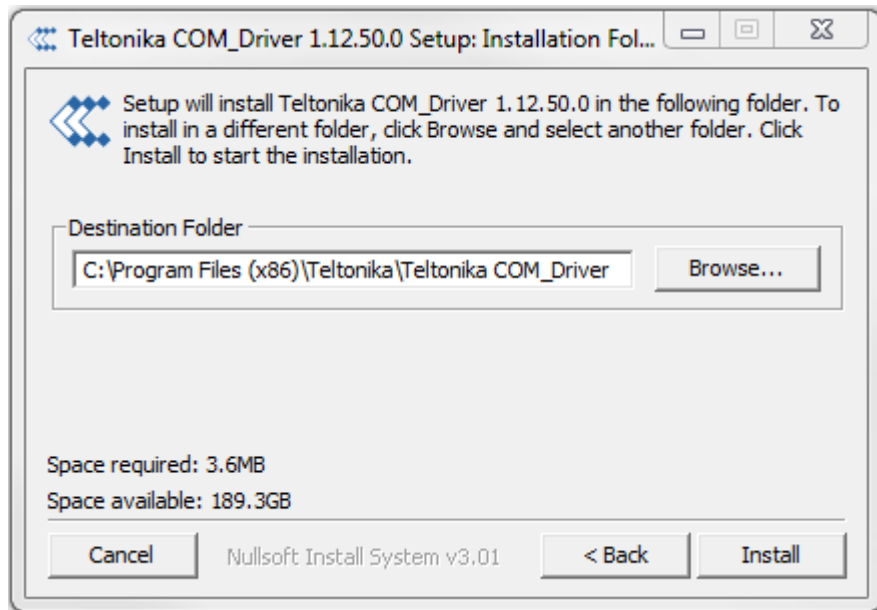

Figure 3 Driver installation window 2

Setup will continue installing drivers and eventually the confirmation window will appear. Click **Close** to complete the setup:

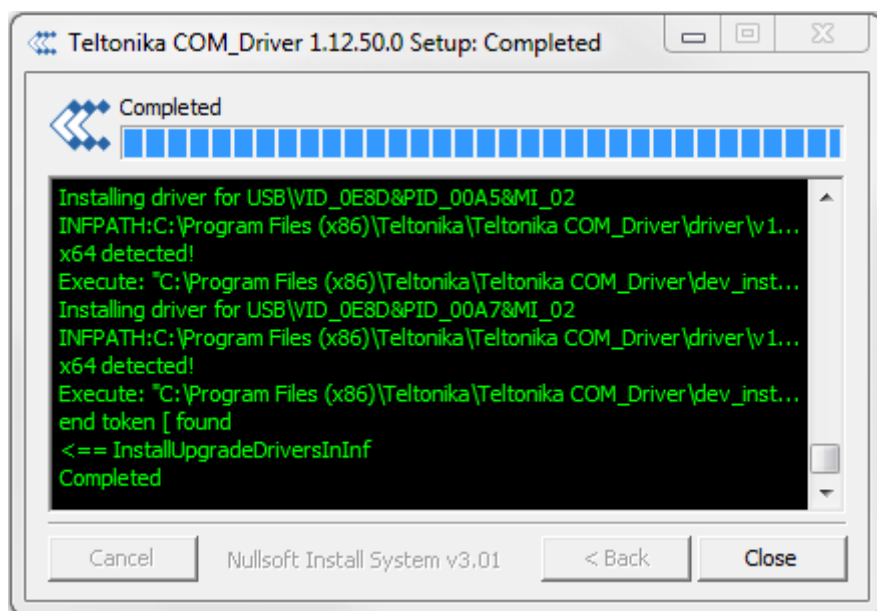

Figure 4 Driver installation window 3

You are now ready to use the device on your computer.

4 OPERATIONAL BASICS

4.1 Operational principles

GH5200 module is designed to acquire records and send them to the server. Records contain GNSS data and I/O information. Module uses GNSS receiver to acquire GNSS data and is run in three (time-based, distance-based and angle-based) acquisition modes. Please note that if GH5200 loses connection to GNSS satellites it continues to make records, however coordinate in these records remains the same (last known coordinate). All data is stored into flash memory and later can be transmitted via GPRS.

GPRS and SMS settings are described in following sections. GH5200 communicates with server using Codec 8 data protocol. GH5200 can be managed by SMS commands, which are described in SMS command section.

4.2 Sleep modes

There are four sleep modes: GPS sleep, Deep sleep, Online Deep sleep and Ultra Deep sleep mode.

4.2.1 GPS Sleep mode

GH5200 is able to go into GPS sleep mode if such mode is enabled.

Sleep mode timeout starts counting when device is in STOP mode. After timeout is reached and all conditions for GPS sleep mode are met, the device goes into sleep mode. When in GPS sleep mode, GH5200 turns GPS module off and continues making new periodic records.

GH5200 will enter GPS sleep mode if **ALL** of these conditions are met:

- GH5200 is configured to work in GPS Sleep mode and sleep timeout is reached;
- Device time is synchronized with GNSS satellites and GPS fix is obtained;
- Movement is not detected by the accelerometer;
- Forced wakeup is not set;
- There are no SMS messages being received.

GH5200 exits GPS sleep mode if following condition is true:

- Movement by accelerometer is detected.

4.2.2 Deep Sleep mode

When in deep sleep mode, GH5200 sets the GNSS receiver to sleep mode and turns off GSM/GPRS module (hence it is not possible to wake up device via SMS). Records with last known coordinate being saved and sent to AVL server - GSM/GPRS module is turned on to send data and then it is turned off. Please note that power saving depends on two configurable parameters: *Send Period* and *Minimum Record Saving Period in "X on Stop Mode"*. When records are sent successfully in deep sleep mode, open link timeout counter will be skipped and GH5200 will enter deep sleep mode immediately.

Because a lot of functions are disabled in deep sleep mode following I/O elements are disabled from records that are generated in this mode: GSM Signal, GNSS Status, GNSS PDOP,

GNSS HDOP, GSM CellID, GSM Area Code, Active GSM Operator and ICCID. GH5200 can enter deep sleep mode if ALL of these conditions are met:

- GH5200 is configured in Deep Sleep mode and sleep timeout is reached;
- Device time is synchronized with GNSS satellites and GPS fix is obtained;
- Movement is not detected by the accelerometer;
- *Min. Record Saving Period (Data Acquisition Mode settings)* must be larger than *Open Link Timeout* parameter, so that GH5200 could close GPRS link;
- The difference between Send Period (*Data Acquisition Mode settings*) and *Open Link Timeout* must be more than 90 seconds, so that GH5200 could close GPRS link within at least 90 seconds;
- Forced wakeup is not set;
- There are no SMS messages being received;
- Data socket(s) are closed;
- Data sending is not in progress;
- FOTA is not in progress.

GH5200 exits deep sleep mode if following condition is true:

- Movement by accelerometer is detected;

4.2.3 Online Deep Sleep mode

In this mode the device works as in deep sleep mode, but without deregistering from GSM network. GSM part stays powered so this increases power consumption. In this mode device should send/receive SMS and make/accept calls. It does not close GPRS context if one was previously opened. Conditions to enter online deep sleep mode are the same as entering deep sleep mode. GH5200 exits online sleep mode if following condition is true. GH5200 exits online sleep mode if following condition is true:

- Movement by accelerometer is detected;

4.2.4 Ultra Deep Sleep mode

Conditions to enter ultra deep sleep mode, where GPS and GSM modem are turned off and device functions are suspended for maximum battery saving, are the same as entering Deep Sleep mode.

GH5200 exits ultra deep sleep mode only when movement is detected by accelerometer. Movement source is not taken into account in this case.

4.3 Features

Using available features can greatly increase GH5200 utilization.

4.3.1 Alarm

Alarm is a feature that can be only triggered by a pressing the configured button. When the alarm is triggered, an event with IO ID 236 is generated. Following a configured button press to activate the Alarm an SMS can be sent and a call can be performed.

Data sending follows in this order: 1. GPRS; 2. SMS; 3. Call.

There are "GPRS and SMS" and "GPRS or SMS" notification methods.

If selected method “GPRS or SMS”. At first device tries to connect to GPRS context using configured APN. If it does not connect device sends sms event to configured number.

If method is “GPRS and SMS” SMS will be sent in both cases, when GPRS has failed and when records are sent to server.

These SMS sending methods are valid for these Events: Alarm; Man Down, Movement Event and Over speeding.

4.3.2 ManDown

ManDown functionality gets current accelerometer data and calculates the angle between offset position. Currently there are two positions: horizontal and Scanning is performed each second. When calculated angle exceeds the configured angle value for 3 seconds an event is generated with configured priority, device can make a voice call or send an SMS notification, if it is configured. When the device returns to allowed base position an event with same priority is generated.

4.3.3 OverSpeeding

This functionality prevents exceeding fixed speed limits and inspects the driver if required.

4.3.4 Movement Event

Movement Event functionality makes an eventual high priority record (and sends an optional SMS) when device is stationary or in motion (depending on configured "Mode") for set *Timeout* (added to "*Movement Start/Stop Delays*" accordingly).

Timeout is a configured amount of time (in seconds) after which an eventual high priority record is generated.

Note: this timeout is added with *Movement Start Delay* if configured *Mode* is *Movement Event* or with *Movement Stop Delay* if configured *Mode* is *No Movement Event*.

Movement Event mode generates a record after the start of movement whereas *No Movement Event* generates a record after the stop of movement.

4.4 Voice call

Device has integrated microphone and a speaker, which allows you to perform two voice call. Voice call is available in normal and loud speaker modes.

Normal speaker mode – when call is answered with low speaker volume, default speaker volume is set to 40%.

Loud speaker Volume. – when call is answered with loud speaker volume, default speaker volume is set to 100%.

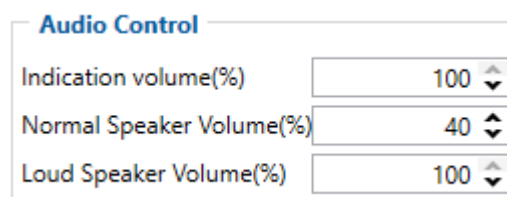

Figure 5 Volume control

4.5 Tracking On/Off

This keyboard functionality, which turns on and off GNSS module on konfigured key pressed.

4.6 Bluetooth

Bluetooth can work in two modes - *slave* or *master*. When in *master* mode Bluetooth can connect to the defined hands-free system. When working in *slave* mode - Bluetooth can accept incoming pairing requests from external devices.



NOTE: GH5200 supports ONE connection at a time.

NOTE: GH5200 can see up to 10 available devices. If there are more than 10 devices the scanning list may change.

4.7 Auto Geofence

Auto Geofence is a feature that notifies the user if the object has left the zone that was generated within set radius around the device. This feature is based on the last known position after the movement has stopped. More details about Auto Geofencing can be found in chapter 5.10.

4.8 Manual Geofence

Geofencing is another feature which is highly customizable and can detect whenever car enters or leaves customized areas. More details about Geofencing can be found out in chapter 5.11.

4.9 User Interface

This section allows to configure GH5200's LED, audio and vibration indication for each scenario using the configurator. More information about this can be found in Chapter 5.16

4.10 Keyboard

There are five configurable buttons in GH5200 - Alarm Button, Power Button, 1, 2 and 3 buttons. More information about this can be found in Chapter 5.17

5 CONFIGURATION

5.1 Configurator

At first GH5200 device will have default factory settings set. These settings should be changed according to the user's needs.

Device can be configured to acquire and send data to server, in this case the GSM settings shall be set in regards with GSM operator's information. If device GSM is unavailable, the device will not be able to send the data and GH5200 will start storing records to flash memory. It is possible to store up to 192000 data records within internal memory (when 100 MB are used to

store records). It will send data over GPRS when it is available. Note that GH5200 might reach its full memory capacity. If such case happens, the device will start deleting the oldest records in order to save new ones.

GH5200 configuration is performed via GH5200 Configurator program. Contact sales manager to get the latest GH5200 Configurator version.

GH5200 configurator operates on Microsoft Windows OS and uses prerequisite MS .NET Framework.

Module configuration can be performed over Micro USB cable or using a Bluetooth connection. Configuration process begins by starting GH5200 Configurator software and then connecting to GH5200 device via **Connect** button located in **Online** menu part. GH5200 has one user editable profile, which can be loaded and saved to the device. After any modification of configuration the changes need to be saved to GH5200 device using **Save to device** button.

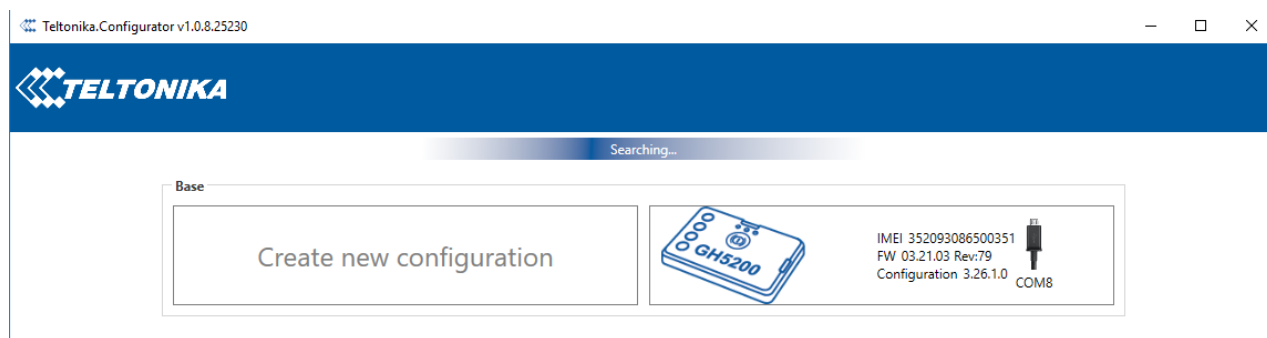

Figure 5 GH5200 configurator window when selecting the connection method

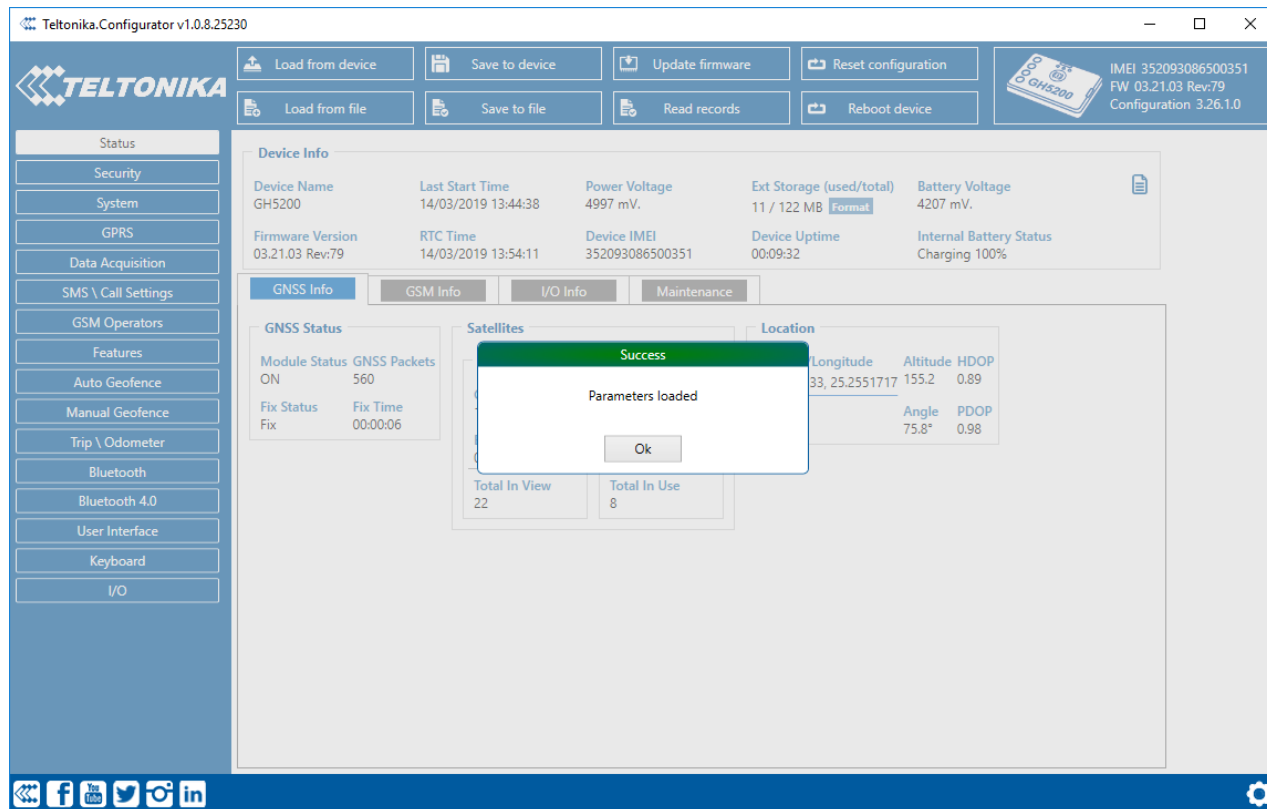

Figure 6 GH5200 configurator main window when connected to it and successfully loaded parameters

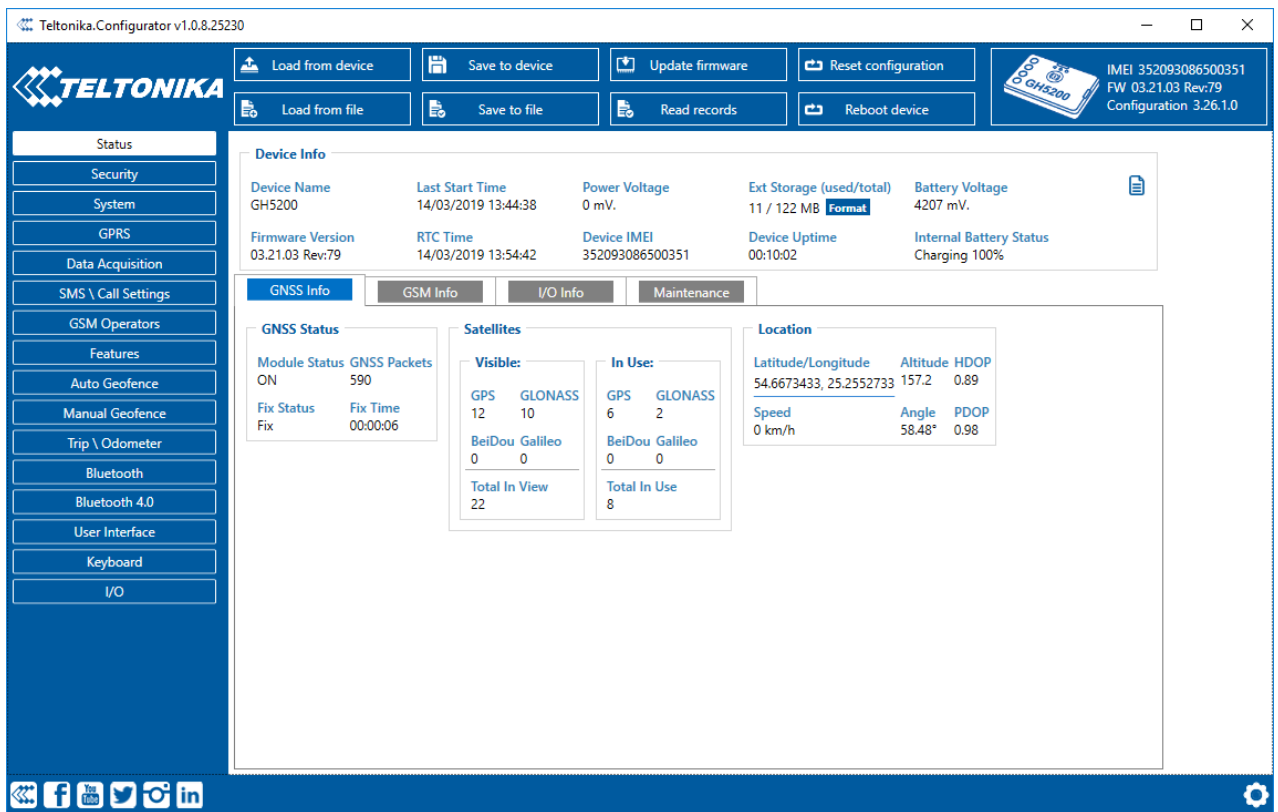

Figure 7 GH5200 status elements

5.1.1 Main Buttons description:

Load from device – loads configuration from device.

Save to device – save configuration to device.

Load from file – load configuration from file.

Save to file – save configuration to file.

Update firmware – update firmware on device.

Reset device – reset device configuration to default.

5.1.2 Keyword SMS (GPRS) commands:

Configuration should not be locked when the user is attempting to set a new keyword, change it or delete it. For example:

Set new keyword (set):

```
<SMS login>{space}<SMS pass>{space}setkey{space}{space}<newkeyword>
```

Change old keyword (change):

```
<SMS login>{space}<SMS pass>{space}setkey{space}<oldkeyword>{space}<newkeyword>
```

Delete current keyword:

```
<SMS login>{space}<SMS pass>{space}delkey{space}<keyword>
```

5.1.3 Keyword configuration with TCP

If keyword is set, it will be saved to configuration file.

If keyword in configuration file does not match keyword in device after TCP configuration, configurator will ask the device keyword. When device is locked, the keyword cannot be changed with TCP configuration.

5.2 Status info

Status info enables the user to monitor real time information of GH5200. Following fields are displayed: *Device Info* field, *GNSS Info* field, *GSM Info* field, *I/O Info* field and *Maintenance* field. User is able to export all of the information to .HTML file using an icon which is at the top right corner of the *Device Info* area.

Device Info shows device name, firmware version, last device start time, RTC Time, power voltage (mV), device IMEI, internal memory free space, device uptime, battery voltage (mV) and internal battery status.

GNSS Info shows:

- Real time GNSS status information: module status (ON, Deep/GPS/Online Sleep mode), the amount of GNSS packets device received from startup, fix status and the last GNSS fix time.
- Satellite information: the amount and type of satellites that are visible, and the amount of satellites used for location positioning.
- Location information: latitude, longitude, altitude, angle, HDOP, PDOP and speed.

GSM Info shows:

- GSM status: modem status, SIM status, GPRS status, actual operator code and GSM signal level.
- GPRS traffic: the amount of data that has been sent and received by the device.
- Sockets information: which server domain and port is used.
- Records: how many records were sent to the server since last data reset, when the last record was sent and when the last server response was.
- SMS count: the amount of SMS messages GH5200 has received and the amount of SMS responses that were sent from the device.

I/O Info shows:

- Values from all configurable I/O elements.

Maintenance shows:

- A “log” option to start capturing log for a set amount of time. Log will be saved to directory set in settings.
- A “Dump” option to start downloading logs from currently connected device. Files will be saved to directory set in settings.
- A “Read” option to start capturing *accelerometer* data for a set amount of time. Log will be saved to directory set in settings.

5.3 Security info

In security section user can see SIM card and configurator keyword security information.

- The state and status of currently inserted SIM card can be observed here. If a SIM card with PIN code is used, user can enter it in this section. The remaining attempts to enter PIN code are shown as well.

- When SIM PIN code is entered correctly user can change PIN code or disable it from the SIM card. When SIM PIN is disabled and user would like to enable it again, user must enter the previously used PIN code.
- Configuration security keyword can be set to configurator. Keyword can be saved in configuration file (.cfg), so there is no need to connect the device to the configurator to configure the keyword. Minimum keyword length is 4 symbols and maximum length is 10 symbols. Only uppercase, lowercase letters and numbers are supported. Keyword can be configured to .cfg configuration file when the device is not connected.

5.4 System settings

System settings have following configurable parameters:

- *Sleep Settings*, where user can choose a sleep mode;
- Records saving settings, where user can enable or disable records when GPS is not available (no time synchronization);
- *GNSS Source* settings, where user can choose the necessary satellite system(s);
- *Power On By USB/Charger* setting. Device supports two working modes: normal mode, where the device works as usual, and charging mode, which is entered when *Power On By USB/Charger* parameter is disabled. To enter normal mode, device can be turned on by power button or by USB charger, if *Power On By USB/Charger* parameter is set to *Enable*.
- *Accelerometer Delay Settings*, where user can configure movement start and stop delay values (in seconds);
- *Time Synchronization* settings, where user can choose which source(s) to use for GH5200 time synchronization. User has a choice to: use only one synchronization source (*Disable (GPS only)*), allow synchronization from both the GNSS and NTP server (*NTP*), select synchronization through GNSS and GSM operator (*NITZ*) or from all three sources (when *NITZ+NTP* is selected). User can select which NTP server (it is possible to configure up to two servers) and what time period to use to resynchronize time.
- *Data Protocol* setting – allows user to choose which protocol version to be used for data sending to server.
- Sleep Exit Source - allows to select exit from sleep mode method. There are exit sources: Movement and Alarm button.

Power saving mode is present in GH5200. It allows users to choose from two possible options:

1. *Performance mode* – High performance mode, where GNSS module is constantly awake for a maximum track quality (excluding when GH5200 is in sleep mode).
2. *Low Power mode* – Battery saving mode, where GNSS module is woken up only when it is time to acquire position. Standard sleep modes are not available in this mode. For this mode to function properly, *Min Period* in “Data Acquisition” tab has to be ≥ 120 seconds.

Static Navigation mode is a filter, which filters out track jumps when the object is stationary. If static navigation filter is disabled, it will apply no changes to GPS data. If static navigation filter is enabled, it will filter changes in GPS position if no movement (as defined by

configured movement source) is detected. It allows filtering GPS jumps when the object is parked (not moving) and GPS position is still traced.

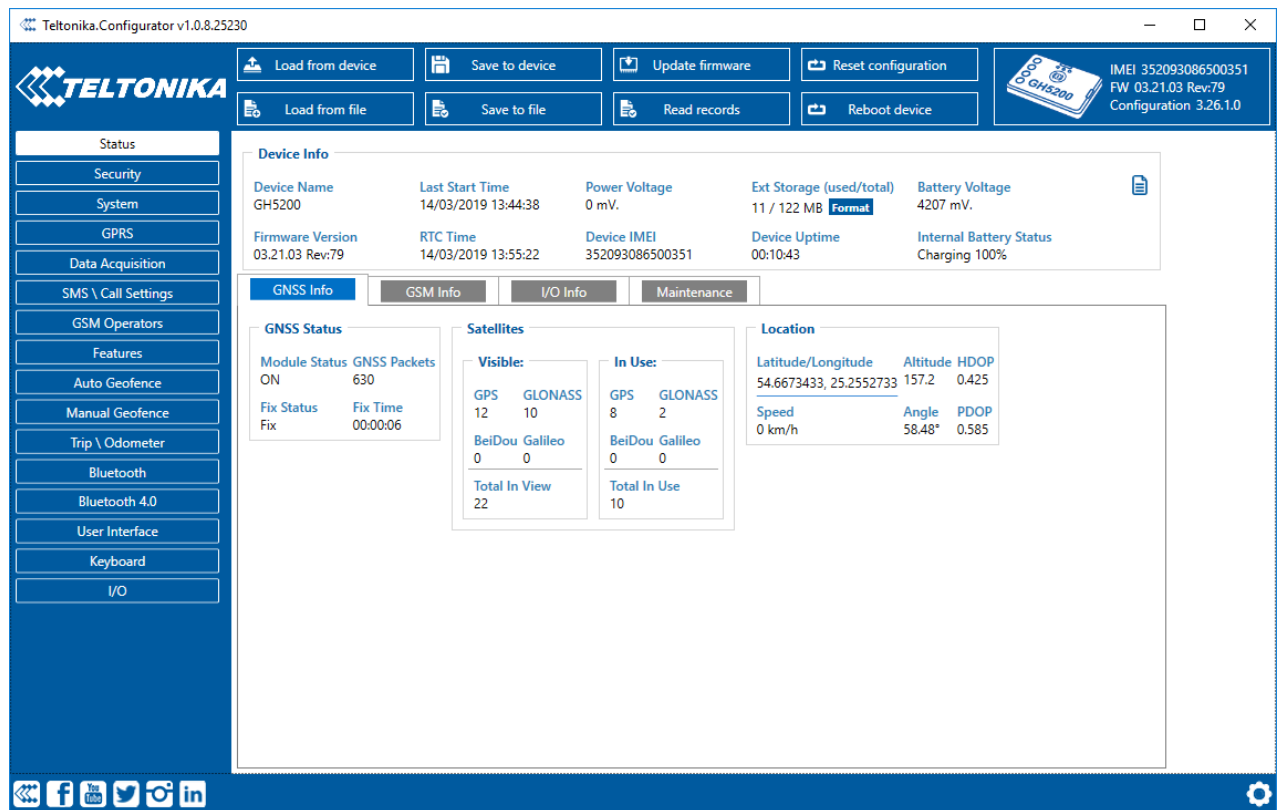

Figure 8 System settings configuration

GNSS Source settings allows user to configure which GNSS system(s) to use. User has a choice to use one system between *GPS*, *GLONASS*, *Galileo* or *BeiDou* and it is possible to choose two or three systems together. One exception is that you cannot combine *BeiDou* and *GLONASS* systems together. Below you will find GNSS source combination examples:

List of **configurable** GNSS sources:

BeiDou only	ID:01
GLONASS only	ID:02
Galileo only	ID:04
Galileo+BeiDou	ID:05
Galileo+GLONASS	ID:06
GPS only	ID:08
GPS+BeiDou	ID:09
GPS+Glonass	ID:10
GPS+Galileo	ID:12
GPS+Galileo+BeiDou	ID:13
GPS+Galileo+GLONASS	ID:14

List of **NON-configurable** GNSS sources:
GLONASS+BeiDou

GNSS source

Beidou	Glonass
Galileo	Gps

Example of good configuration

GNSS source

Beidou	Glonass
Galileo	Gps

Galileo+GLONASS+BeiDou
 GPS+GLONASS+BeiDou
 GPS+Galileo+GLONASS+BeiDou

Example of bad configuration

5.5 GPRS

GPRS settings define main parameters for GH5200: GSM operator *APN* and *GPRS Username* and *Password* (optional – depending on operator), destination server IP and port, and allows setting the protocol used for data transfers – *TCP* or *UDP*. Backup server settings can also be selected for *Backup server*.

Backup server has 3 different modes:

- *Disable*: backup server is not used.
- *Backup*: records are sent to backup server if main server is not available (for example fails to open link) or when main server response timeout is reached successively 5 times.
- *Duplicate*: records are sent to both servers (main and backup), records are deleted from SD-card (or RAMS) only if both servers accepted the records.

Some operators use specific type of authentication for GPRS session – *CHAP* or *PAP*. One of these should be selected depending on your GSM operator. Information about APN and authentication type should be provided by your GSM operator as well.

GH5200 device will send the newest records first when *Newest* is selected in *Records Settings*, which is useful in cases when the most important parameter set is the most recent one, as a result other records will be sent right after the newest records are received by AVL application.

Open Link Timeout is used to set termination timeout for link between GH5200 and AVL application. If GH5200 has already sent all records it waits for the new records before closing the link (except for *Deep Sleep* mode, for more information refer to Deep Sleep mode). If new record is generated and link is still open, it is sent to server immediately without waiting for send period. This option is useful when GSM operator charges for link activation.

Response Timeout is used to set a period of time waiting for the response from server side.

FOTA WEB settings are used to configure FOTA WEB server connection parameters. *Status* enables or disables FOTA WEB functionality. Address and port number of FOTA website are entered to *Domain* and *Port* fields. *Period* is used to set the timeout of repeat connections to the FOTA WEB server.

The connection to FOTA WEB may be forced without waiting the specified period by sending the following SMS command: <SMS login>{space}<SMS pass>{space}web_connect

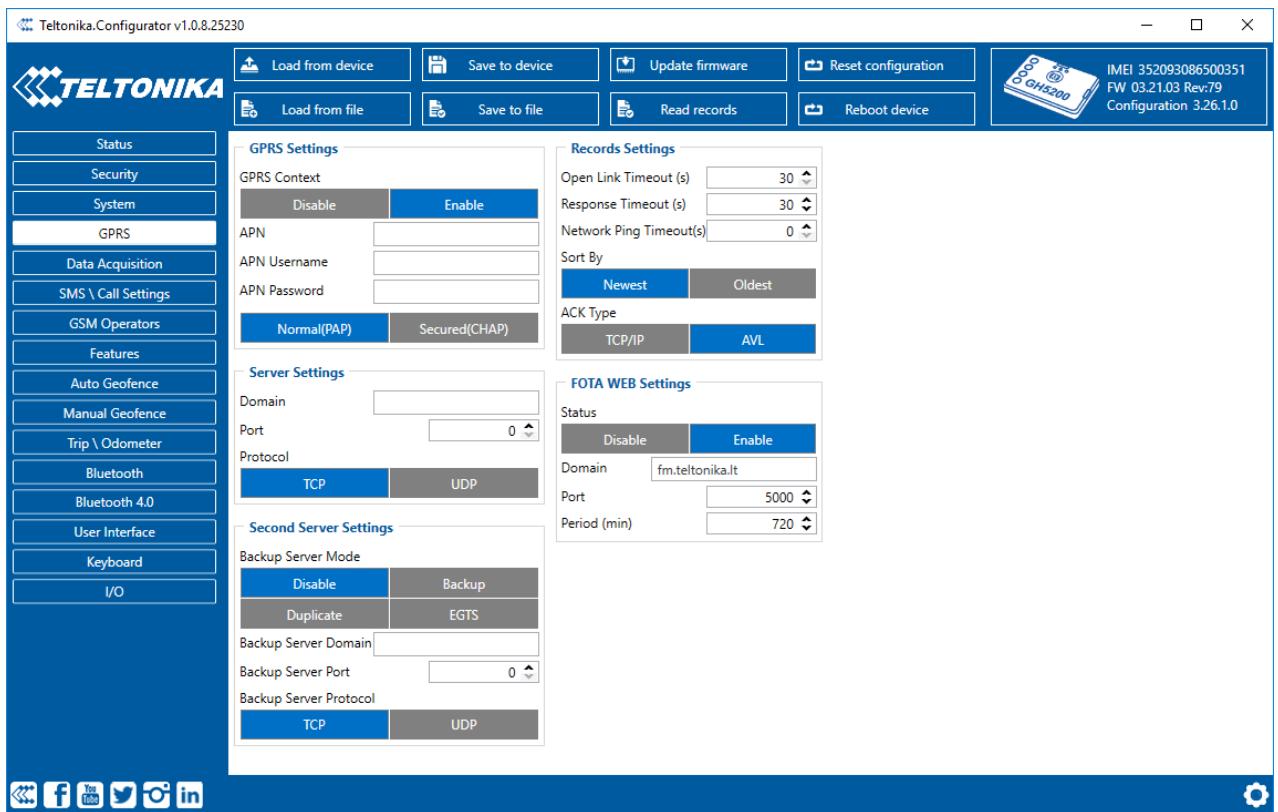

Figure 9 GPRS configuration

5.6 SMS/Call Settings

Essential fields in **SMS/Call Settings** are *Login* and *Password*. The login and password are used with every SMS sent to GH5200. If login and password are not set, in every SMS sent to GH5200 device two spaces before command have to be used (<space><space><command>).

Command structure with set login and password:

<SMS login><space><SMS password><space><command>, for example: "asd 123 getgps"

Phone numbers have to be written in international standard. Using "+" is optional but not necessary (in both cases number will be recognized, but when number is without "+" symbol, IDD Prefix will not be generated, which depends on location of the phone). If no numbers are entered, configuration and sending commands over SMS are allowed from all GSM numbers.

SMS data sending settings allow sending AVL data using binary SMS. AVL data will be sent by SMS only when there is no GPRS connection. This setting does not affect replies to SMS request messages – answers are always sent back to the sender's telephone number.

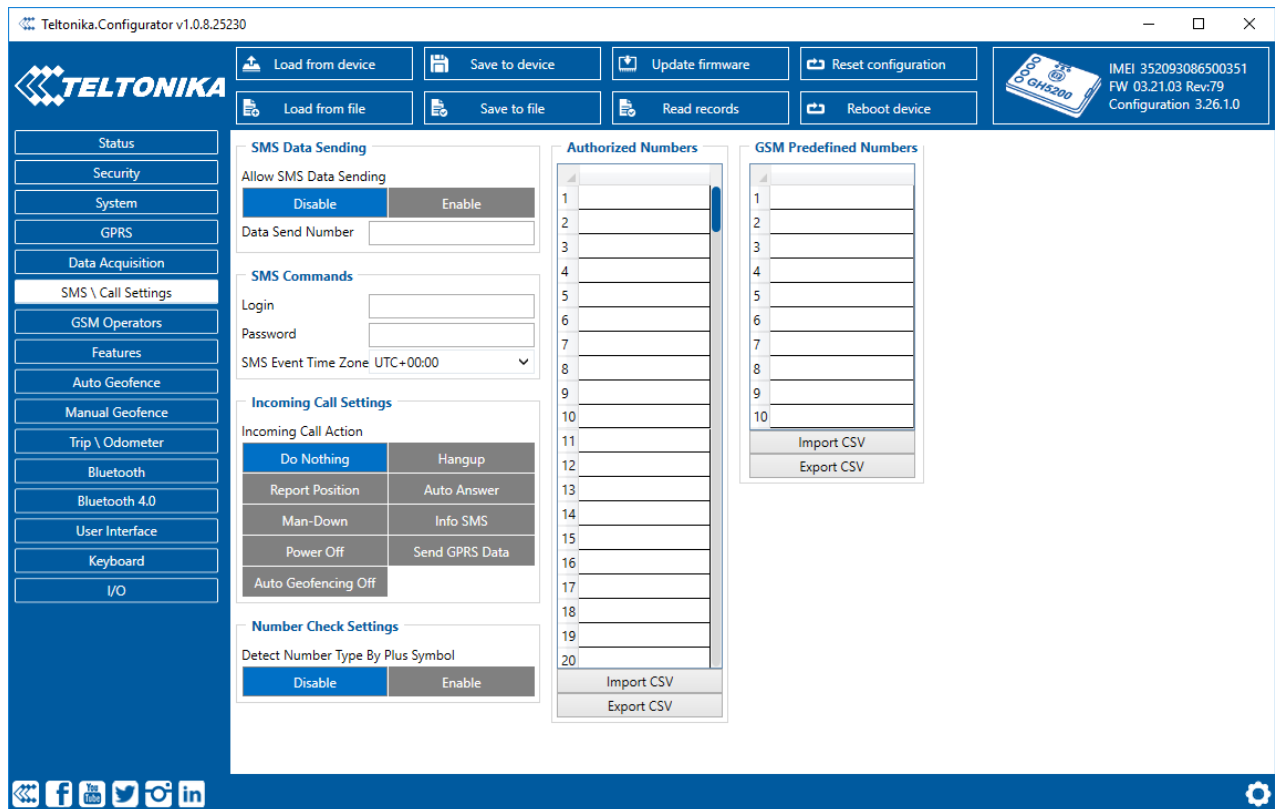

Figure 10 SMS/Call Settings configuration

Incoming call settings parameter defines device action during incoming call:

- *Do Nothing (BT HF)* – Device will ignore incoming call.
- *Hangup* – Automatically hang up an incoming call.
- *Report Position* – Device will send SMS with it's GNSS location to caller number and hang up incoming call.
- *Auto Answer (HF)* – Auto answers incoming call in normal speakers mode.
- *Man-Down* – Auto answer incoming call if Man-Down event is detected
- *Info SMS* – Device will send info SMS to caller number and hang up incoming call.

Info SMS format:

Date: <date> Time: <time>; IMEI: <imei>; Version: <version>; BatLvl: <batlvl>; OpId: <operator_id>; GSMSignLvl: <gsm_signal_level>

- *Power Off* – Hang up incoming call and turn device off.
- *Send GPRS Data* – Hang up incoming call and start sending records to server.
- *Auto Geofencing Off* – Turn off Auto Geofence scenario.

When *Number Check Settings* option is enabled, numbers with “+” symbols will be used as international and numbers without it - as local/unknown.

GH5200 works in synchronized GPS time which is UTC+0, with this option customer can configure the time zone and get SMS messages with correct time.

5.7 GSM Operators, Roaming, Blacklist Operator list

GH5200 can work in different modes (use different settings) according to the operator list defined. Operator list is used for *Data Acquisition* mode switching (see Data Acquisition Mode

settings section for more details). Modes are changed based on GSM operator GH5200 is connected to.

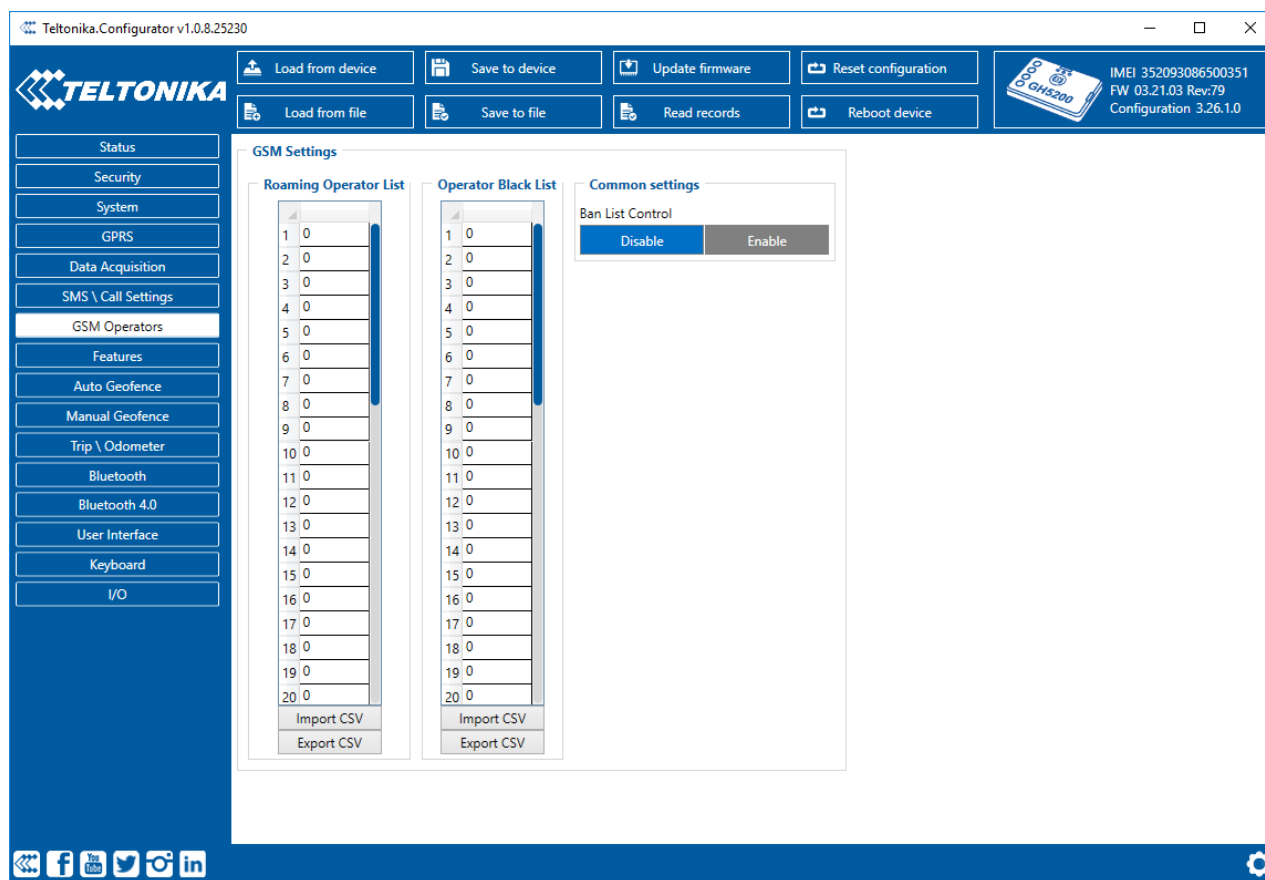

Figure 11 Roaming and Operator BlackList configuration

If roaming operator list is left empty, GH5200 will automatically detect home operator. If home operator is written to the roaming operator list, it will still be detected as home operator. Any operator not in the roaming operator list (except the home operator) will be recognized as unknown operator and GH5200 will work in Unknown mode (make sure it is configured to allow data sending – GPRS context is enabled).

If user wants GH5200 to not connect and work with a particular operator it has to be written to *Operator Blacklist*. Up to 50 operators may be entered to this list.

Operator search procedure is initiated as normal every 15 minutes and tries to connect to an operator providing the strongest signal. It will prioritize operators which are specified in the operator list. If no operators from the operator list are available, the device will try to connect to an operator from the blacklist. If device connects to an operator from the blacklist, best operator search procedure is initiated instantly. During the time when device is connected to blacklisted operator no GPRS connection would be initiated and no data would be sent via GPRS. However, the ability to send SMS commands to the device would remain. If no suitable operator is found on both lists, the device will try to connect to a remaining available operator with the strongest signal.

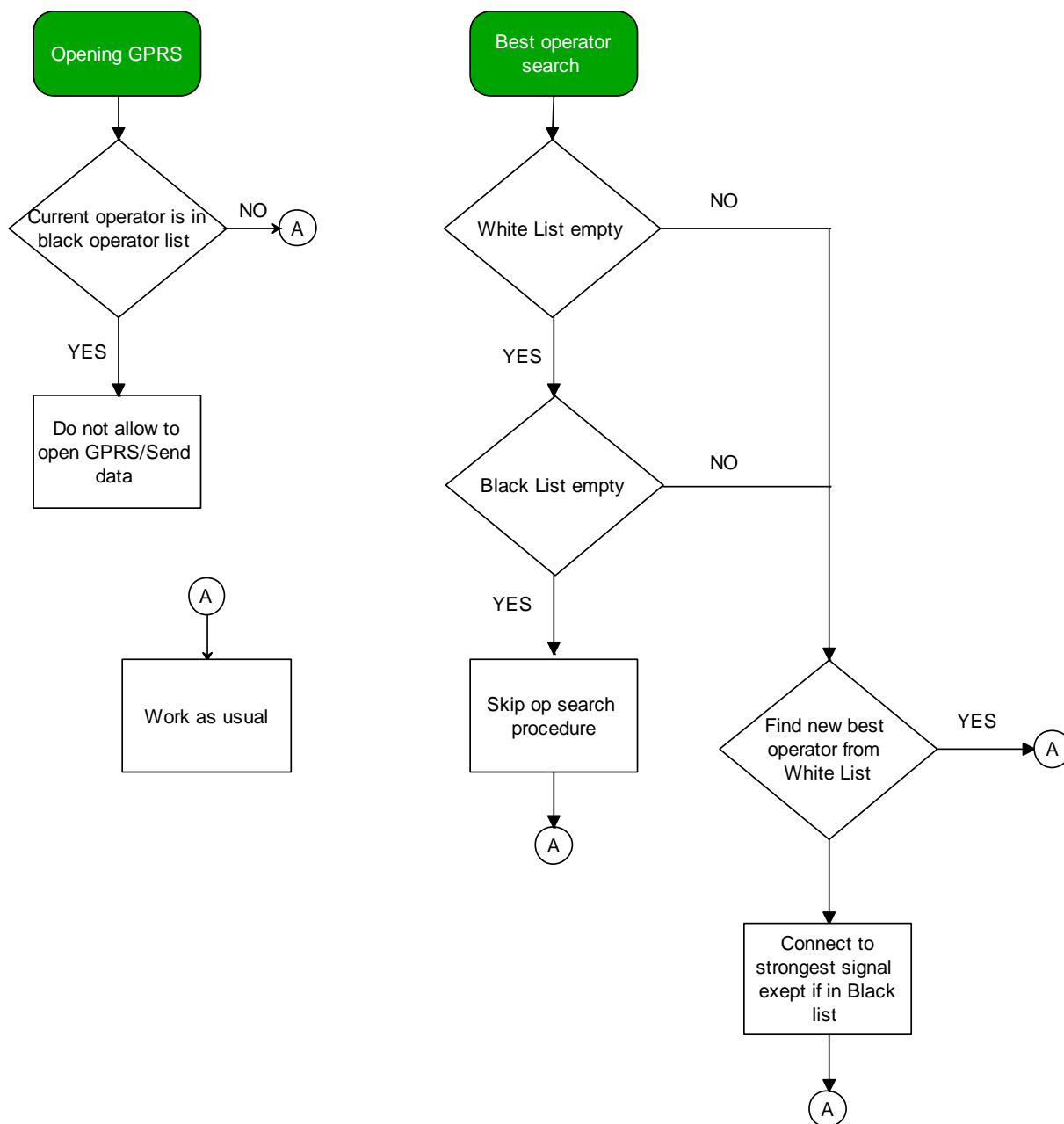

Figure 12 Operator search functionality diagram. White list is Roaming Operator lists

5.8 Data Acquisition Mode settings

Data Acquisition modes are an essential part of GH5200 device, they are also highly configurable.

Through configuration user defines how records will be saved and sent. There are three different modes: Home, Roaming and Unknown. All these modes with configured data acquisition and report frequencies depend on current GSM Operator defined in the Operator list (see section GSM Operators, Roaming, Blacklist Operator list) and are switched when GSM operator changes (e.g. vehicle passes through a country border).

If current GSM operator is defined as Home Operator, device will work in Home Data Acquisition mode, if current operator is defined as Roaming Operator, device will work in

Roaming Data Acquisition mode, and if current operator code is not written in the Roaming Operator list, device will work in Unknown mode.

This functionality allows having different AVL records to acquire and send parameter values when object is moving or standing still. GH5200 has 6 different modes. Operational logic is shown in **Figure 13**.



If home operator is written to roaming operator list, it will still be detected as home operator.

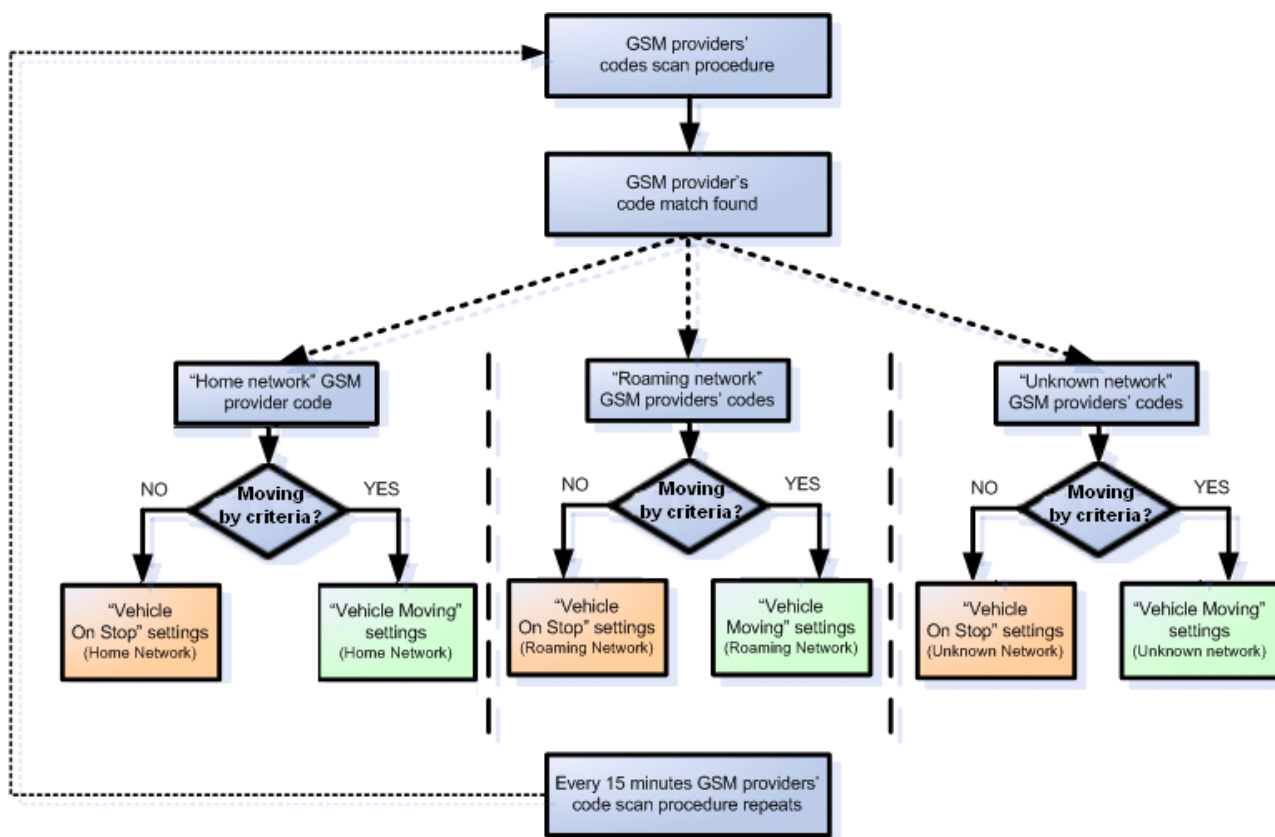

Figure 13 Data Acquisition Mode operational logic

Operator search is performed every 15 minutes. Depending on current GSM operator Home, Roaming or Unknown mode can be changed faster than every 15 minutes. This process is separate from operator search. Movement criteria are checked every second.

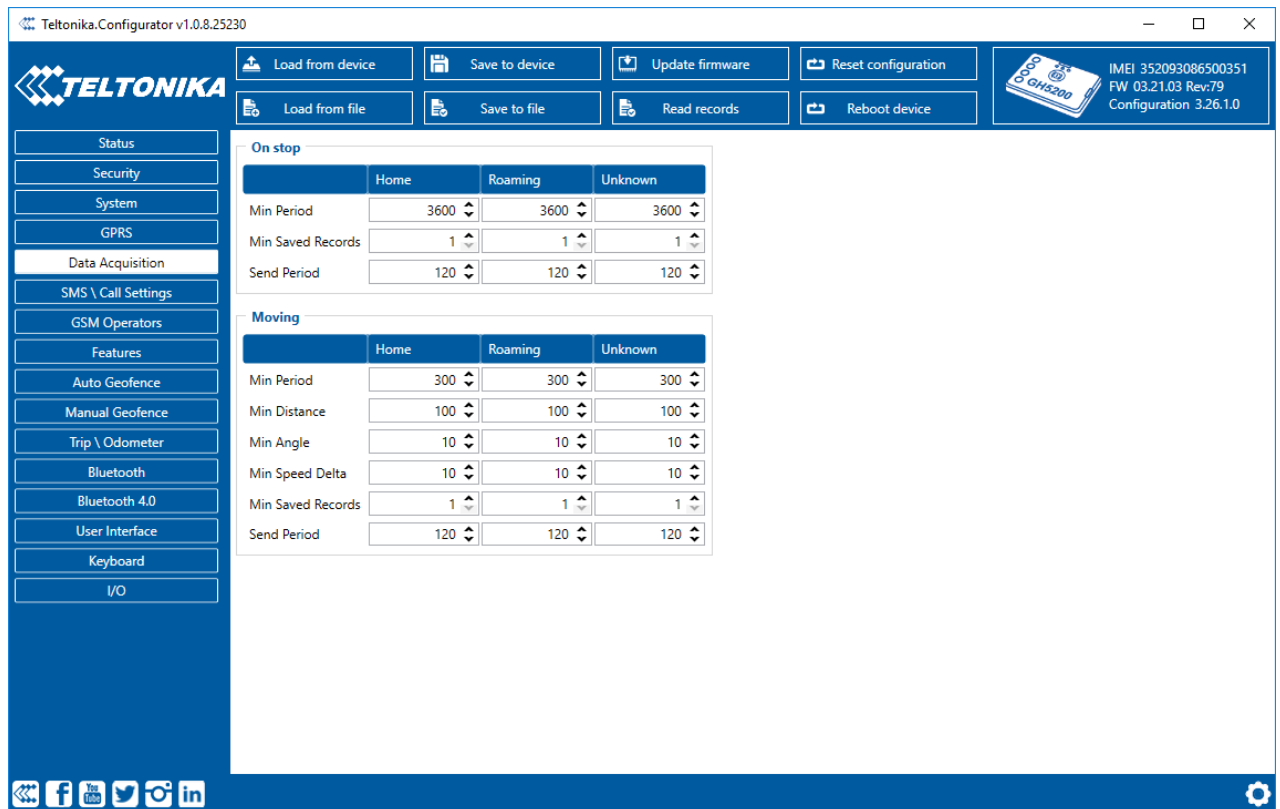

Figure 14 Data Acquisition Mode configuration

Min Saved Records defines minimum number of coordinates and I/O data that should be transferred within a single connection to the server. If GH5200 does not have enough coordinates to send to the server, it will check again after a time interval defined in *Send Period* field.

Send period controls the frequency of GPRS data being sent to server. Module makes attempts to send collected data to the server every defined period of time. If it does not have enough records (depends on the parameter *Min. Saved Records* described above), it tries again after the defined time interval.



Note: Keep in mind that GH5200 operates in GMT:0 time zone, without daylight saving.

GH5200 is able to collect records using four methods at the same time: time, distance, angle and speed based data acquisition:

1. Time based data acquisition (*Min Period*) – records are acquired every time when a defined interval of time passes. Entering zero disables data acquisition based on time.

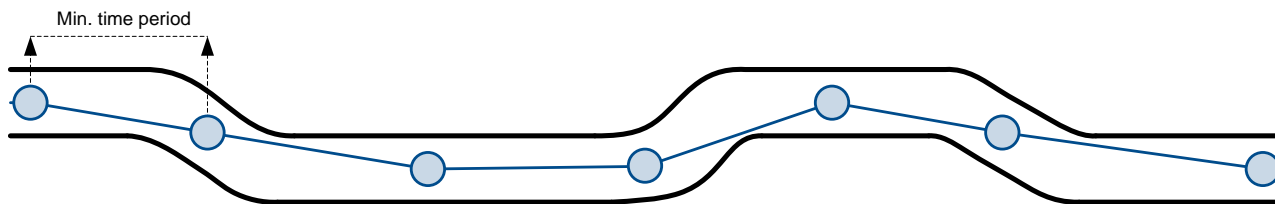

2. Distance based data acquisition (*Min Distance*) – records are acquired when the distance between previous coordinate and current position is greater than a defined parameter value. Entering zero disables data acquisition based on distance.

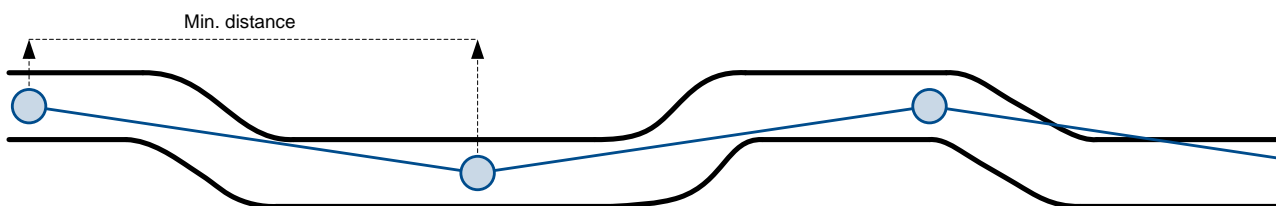

3. Angle based data acquisition (*Min Angle*) – records are acquired when the angle difference between last recorded coordinate and current position is greater than a defined value. Entering zero disables data acquisition based on angle.

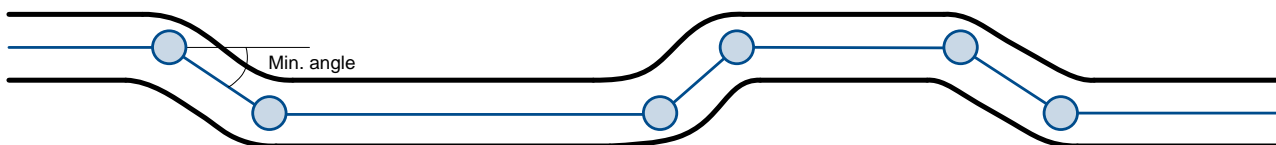

4. Speed based data acquisition (*Min Speed Delta*) – records are acquired when the speed difference between last recorded coordinate and current position is greater than a defined value. Entering zero disables data acquisition based on speed.



5.9 Features settings

Three different scenarios can be selected in *Features* window.

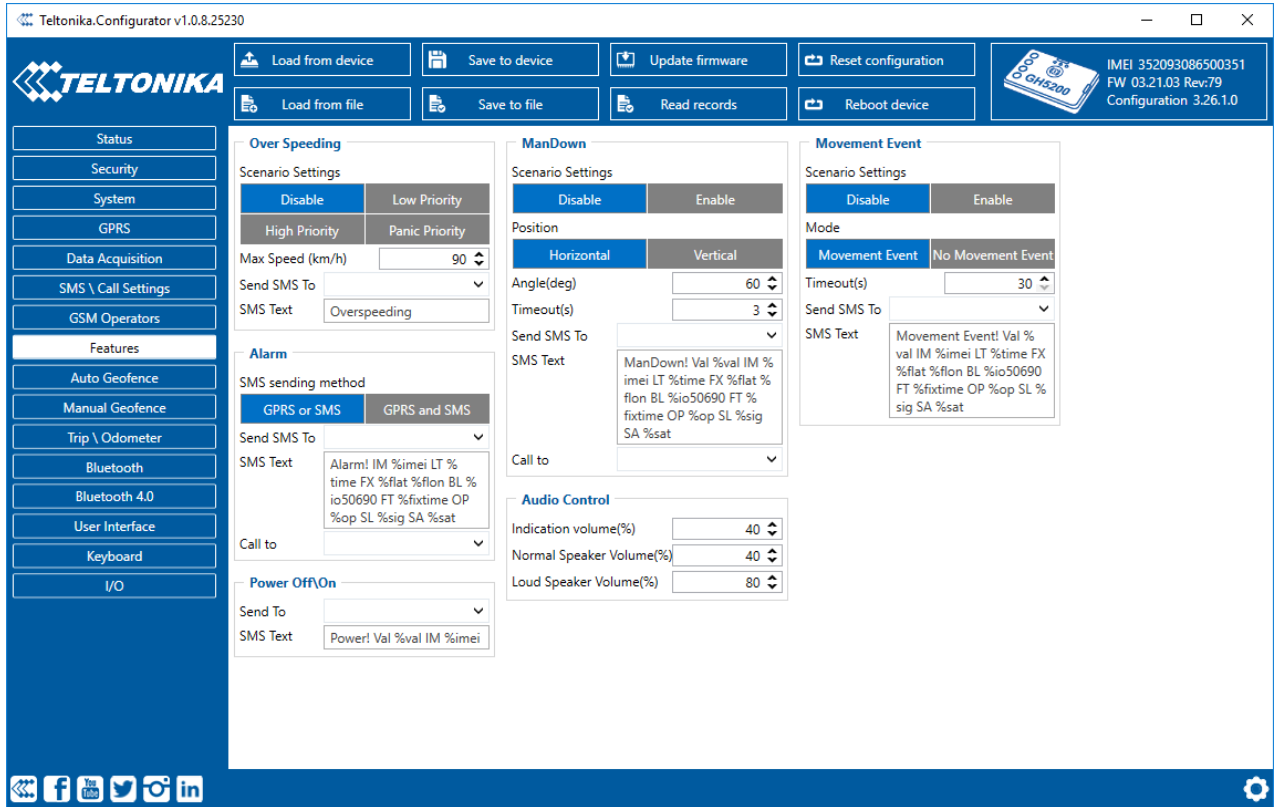

Figure 15 Scenarios configuration

5.9.1 Alarm

This function can be only triggered by a button (Power Button or Alarm Button). When the alarm is triggered, an event with IO ID 236 is generated. Eventually an SMS will be sent and a call can be performed.

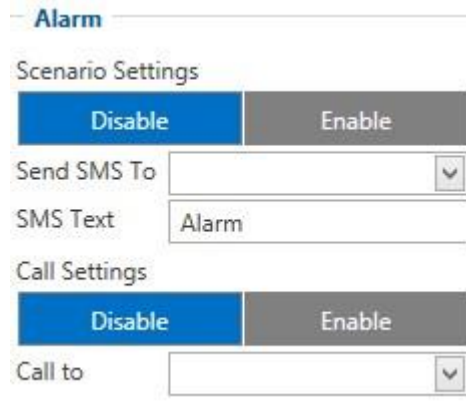

Figure 16 Alarm parameters

5.9.2 Over Speeding

This feature is used to prevent the driver from exceeding fixed speed and inspects the driver if needed. When vehicle speed exceeds maximum configured speed value the scenario is activated, and a record is generated. Scenario is activated until speed value decreases below the set parameter value.

Figure 17 Over Speeding parameters

5.9.3 ManDown

This feature gets current accelerometer data and calculates angles between offset positions. There are two positions: horizontal (when GPS antenna is in horizontal position facing the sky) and vertical. Scanning is performed each second. When calculated angle exceeds configured angle for configured time period, then an event is generated with configured priority and an SMS event takes place, if it is configured. When angle returns to allowed position, an event with the same priority is generated, an SMS can be sent and a call can be performed, if it is configured.

Figure 18 ManDown parameters

5.9.4 Movement Event

Movement Event functionality makes an eventual high priority record (and sends an optional SMS) when device is stationary or in motion (depending on configured "Mode") for set *Timeout* (added to "Movement Start/Stop Delays" accordingly).

Timeout is a configured amount of time (in seconds) after which an eventual high priority record is generated.

Note: this timeout is added with *Movement Start Delay* if configured *Mode* is *Movement Event* or with *Movement Stop Delay* if configured *Mode* is *No Movement Event*.

Movement Event mode generates a record after the start of movement whereas *No Movement Event* generates a record after the stop of movement.

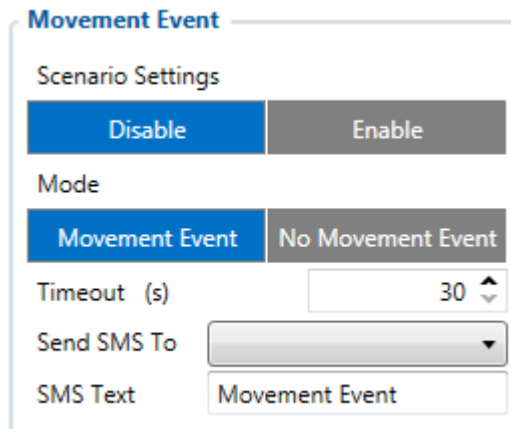

Figure 19 Movement Event parameters

5.10 AutoGeofencing settings

AutoGeofence is based on the last known position after the movement has stopped. You can be notified using this feature if the object has left the generated zone. The size of Geofence zones are set by parameters. AutoGeofencing options can be configured by following parameters as depicted in **Figure 19** below.

AutoGeofence zone is generated *immediately* within set *Radius* value around tracker's most recent position, when Auto Geofencing is enabled over *Keyboard*. Scenario can also be activated through a SMS/GPRS command and can be disabled by SMS/GPRS, configured button or a call. To disable Auto Geofencing scenario with a call, configure *Incoming Call Settings* to Auto Geofence Off and set authorized numbers if such are used.

Note that AutoGeofencing does not require entering coordinates, instead it requires GPS visibility.

Auto Geofence

Scenario Settings

Disable	Low Priority
High Priority	Panic Priority

Eventual Records

Disable	Enable
---------	--------

Radius (m)

Send SMS To

SMS Text

Call Settings

Disable	Enable
---------	--------

Call To

Figure 20 Auto Geofence configuration

5.11 Manual Geofence

GH5200 has 50 configurable Geofence zones and it can generate an event when a defined Geofence zone border is crossed. Frame border is an additional border around Geofence zone used to prevent false events when object stops on the border of the area and as a result records are made inside and outside the defined area because of GNSS errors. The event is generated only when both (Geofence and frame) borders are crossed. See **Figure 20** for details: blue track is considered to have entered the area whereas red track is not.

Shape can be a rectangle or a circle as defined by the user.

Priority of Geofence event is categorized into Low, High or Panic levels. These levels define the priority of event information that is sent to the server. For more details about priorities look in I/O settings section.

Generate event allows to choose when record will be generated.

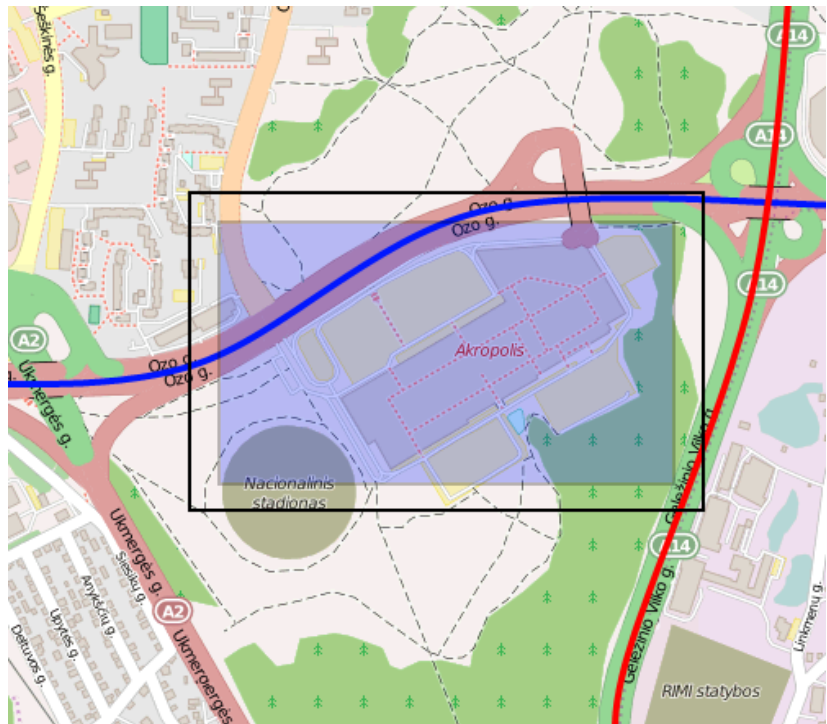

Figure 21 Geofence border

Eventual records controls where scenario status value appears: when disabled it will exist in each AVL record and when enabled the value will be appended only to eventual records.

OverSpeeding helps to configure *OverSpeeding* scenarios separately for each different Geozone. Regular *OverSpeeding* and geozones' *OverSpeeding* function independently. If digital output control is enabled in a regular *OverSpeeding* scenario, geozones *OverSpeeding* scenario will control it too i.e when the device is in more than one geozone and *OverSpeeding* is detected in any zone then the digital output turns on. Digital output turns off only when *OverSpeeding* is not detected anywhere.

X1 is used to set geofence zone left bottom corner X coordinate (longitude) whereas Y1 is used to set Y coordinate (latitude).

X2 or R are used to set accordingly geofence zone upper right corner X coordinate (longitude) when Rectangular zone is used or circle radius when Circular zone is used. Y2 sets geofence zone upper right corner Y coordinate (latitude) for a Rectangular zone.

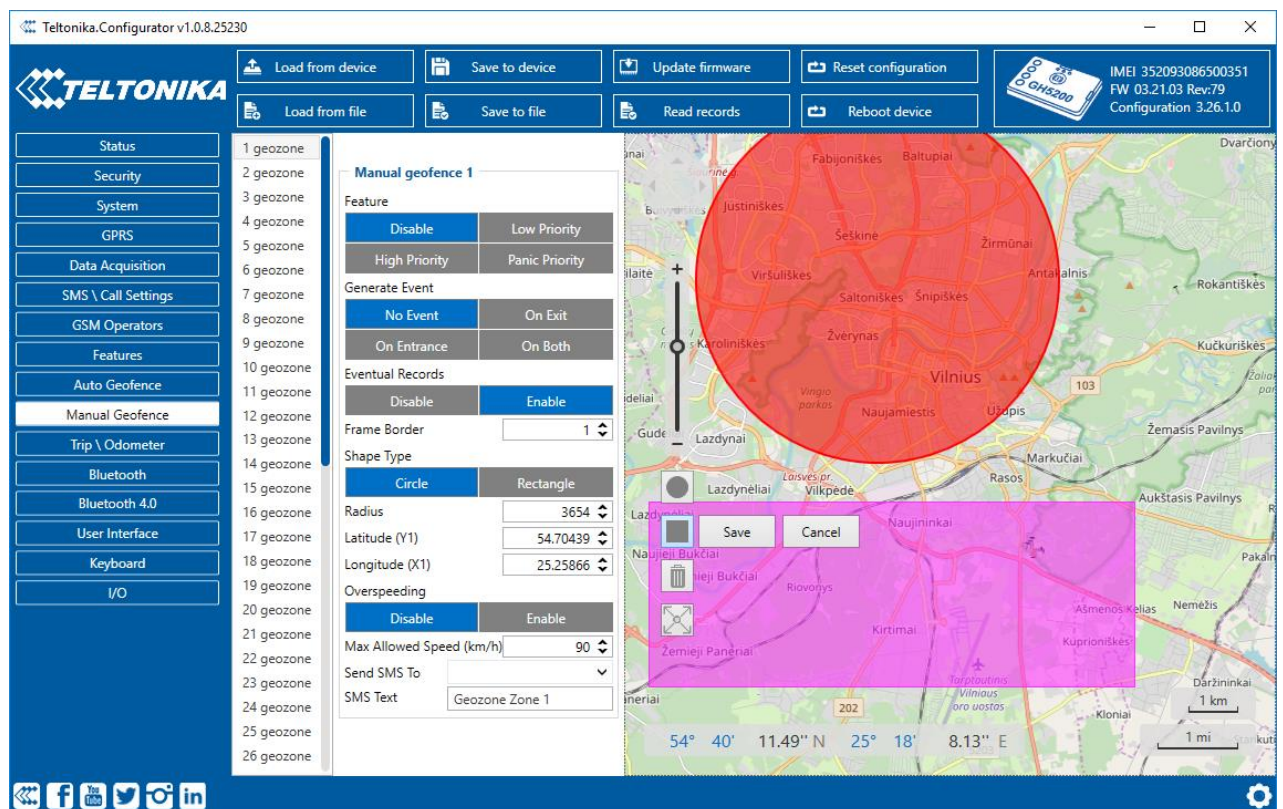

Figure 22 Geofence configuration

5.12 Bluetooth

5.12.1 General functionality

General functionality configures Bluetooth to work in slave mode. This mode allows any external device to connect to GH5200.

Parameter *BT Radio* allows enabling or disabling Bluetooth. There are three different settings:

- *Disabled* – Bluetooth functionality will be disabled.
- *Enable (hidden)* – Bluetooth functionality will be enabled, external devices will be able to connect to GH5200, but no devices will be able to detect it.
- *Enable (visible)* – Bluetooth functionality will be enabled and any external device will be able to detect and connect to GH5200.

Local Name parameter lets user declare a visible name of GH5200 to external devices.

Local PIN parameter lets user configure Bluetooth PIN of GH5200 device.

GH5200 Bluetooth has several different *Security Modes*:

- *PIN only* – only Local PIN will be reacquired to complete connection to GH5200.
- *PIN + MAC list* – PIN and *Authorized Devices MAC List* will be checked against to allow connection to GH5200. If the external device MAC ID is in the list and correct *Local PIN* is entered then connection will be established, otherwise GH5200 will reject connection.
- *MAC list only* – only *Authorized Devices MAC List* will be checked when trying to connect to GH5200. If external device MAC ID is in the list then connection will be established, otherwise GH5200 will reject connection.
- *None* – neither *Local PIN* nor *Authorized Device MAC List* will be checked.

Auto connection functionality configures GH5200 as master device, which allows connecting GH5200 to an external device. GH5200 currently supports these modes:

- *None* – disables auto connection functionality.
- *Hands Free* – GH5200 starts searching for an external hands free headset. If GH5200 finds a device which matches user defined *External MAC* or *External Name* then GH5200 will try to pair with that external device. If the

General

BT Radio

Disable	Enable (hidden)
Enable (visible)	

Local Name

Local PIN

Security Mode

PIN only	PIN + MAC list
MAC list only	None

Auto Connect To External Device

Connection Mode

None	Hands Free
Data Link	

External MAC

External Name

External PIN

Authorized Devices MAC List

1	<input style="width: 90%;" type="text"/>
2	<input style="width: 90%;" type="text"/>
3	<input style="width: 90%;" type="text"/>
4	<input style="width: 90%;" type="text"/>
5	<input style="width: 90%;" type="text"/>
Import CSV	
Export CSV	

Figure 23 Bluetooth

external device asks for PIN then GH5200 will send user defined *External PIN*. After successfully pairing GH5200 will connect to paired device.

- Data Link – BT Data link mode is enabled by Configurator *Data Link* parameter: when *Data Link* is configured and GH5200 has a link with the server, paired device can send messages via Bluetooth SPP profile directly to the server. Messages will be encoded by codec12.



***GH5200 supports ONE connection at a time.
GH5200 can see up to 10 available devices. If there are more than 10 devices, the list may change with each new scan.***

External Name parameter works as a substring, which allows user to enter a part of the full external device name. For example, if external device name is "HandsFreeHeadset" and user enters "HandsFree" in *External Name* parameter window, then GH5200 will be allowed to connect to an external device named "HandsFreeHeadset".

5.12.2 How to connect Bluetooth Hands Free adapter to GH5200 device

5.12.2.1 Bluetooth settings configuration

These are instructions on how to easily create a connection between a Bluetooth Hands Free device and GH5200 device. First the GH5200 device Bluetooth settings need to be configured. These are the required steps:

- Connect GH5200 device to PC using USB cable.
- Launch GH5200 Configurator and connect to the device as shown in **Figure 23**.

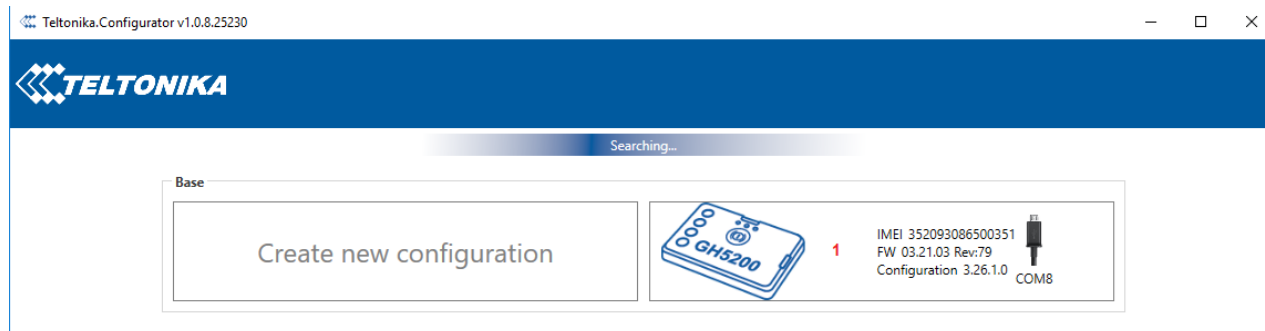

Figure 24 GH5200 configurator devices connection window

- After successful connection to the device wait a few moments while the device loads the current configuration, then navigate to Bluetooth section as shown on **Figure 24**.

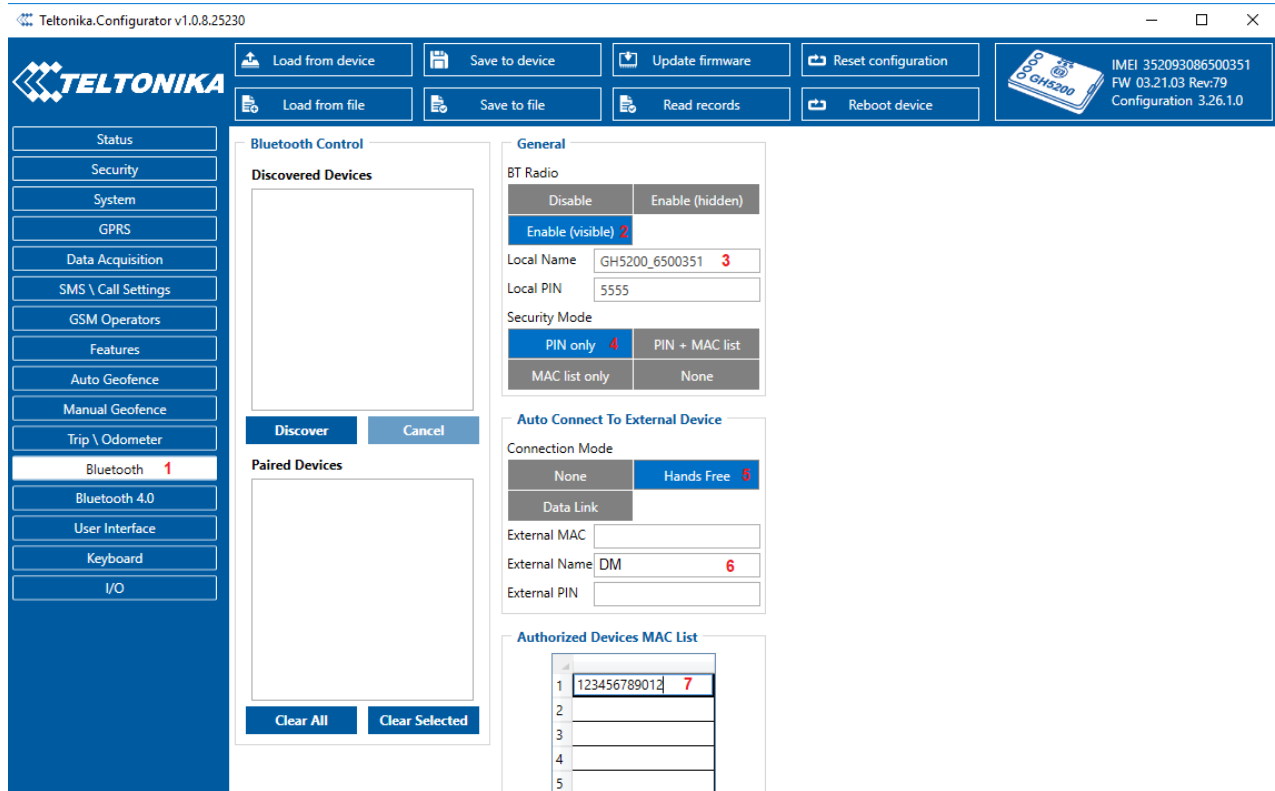

Figure 25 1 – Bluetooth settings; 2 – Enable Bluetooth; 3 – Bluetooth local name; 4 – Bluetooth security mode; 5 – Hands Free connection mode; 6 – External BT device name; 7 – Authorized Devices MAC list

- When device configuration is loaded press **Bluetooth** settings (**Figure 24** position 1).
- Turn on BT Radio by pressing Enable (visible) (**Figure 24** position 2). Local name (**Figure 24** position 3) will be "GH5200_last 7 imei digits" by default, which can be changed.
- Set *Security Mode* (**Figure 24** position 4) to *PIN only* or *None*. *PIN + MAC list* or *MAC list only* security modes could also be selected, but in that case external device MAC address is required to be entered to *Authorized Devices MAC List* (**Figure 24** 7 position).
- Set connection mode to *Hands Free* (**Figure 24** position 5).
- Set *External Name* (**Figure 24** position 6) as your hands-free device name for proper identification. In the given example hands-free headset name is "DMH10" but at least 2 characters are required to recognize it and connect to it. For better and quicker adapter identification on the network you could enter a full device name. You could check your hands-free adapter Bluetooth name by scanning nearby Bluetooth devices using a mobile phone or a computer with Bluetooth adapter.
- Go to **SMS/Call Settings** in main menu and set *Incoming Call Action* to *Do Nothing* as shown on **Figure 25**.

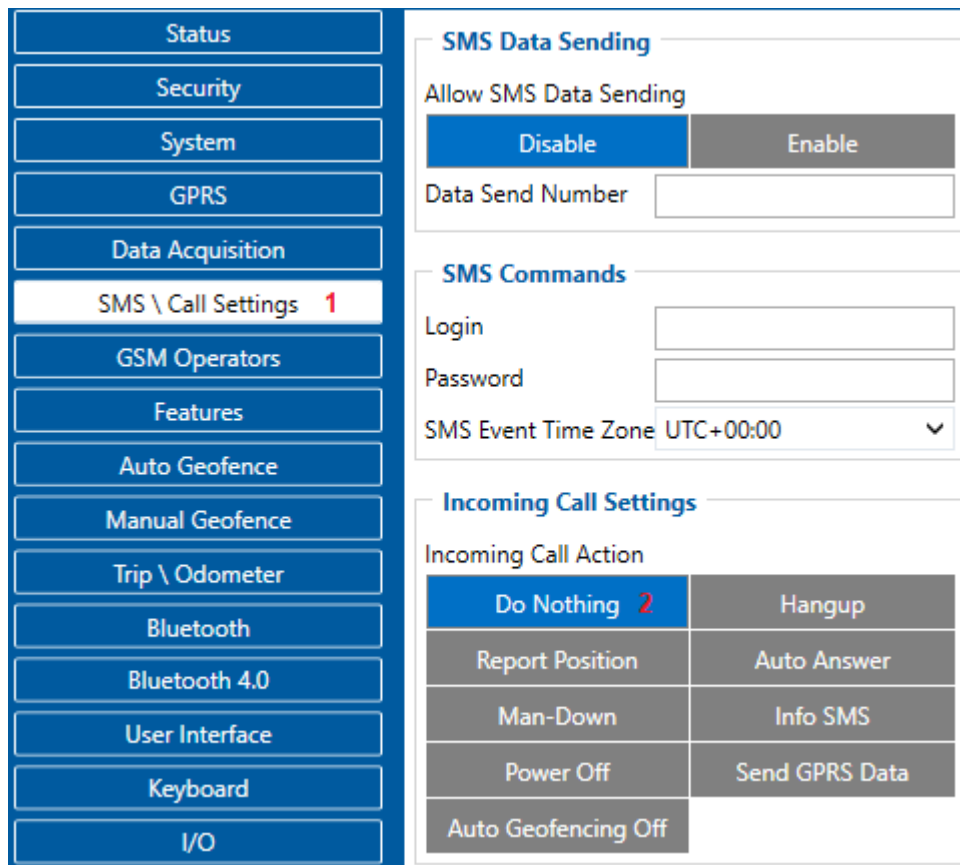

Figure 26 Incoming Call Action settings

- After all these steps press *Save to device* to save configuration.
- Now GH5200 device can be disconnected from the configurator.

5.12.2.2 Connecting Bluetooth Hands Free adapter

Turn on hands-free device and then turn on its Bluetooth connection for pairing following your model instructions. Hands-free adapter should make a specific sound in the speakers or its LED identification should inform about successful connection. To check if the adapter is successfully connected, dial the GH5200 device phone number and the hands-free device should start ringing. If you later restart GH5200 device it will automatically reconnect to this adapter.

5.12.3 Logging the GH5200 device using your mobile phone

Bluetooth starts automatically when GH5200 device is on. Take your mobile phone, go to **Settings->Bluetooth** and turn it on. Scan for nearby devices, find the device in the list, distinguish the device by last IMEI digits on device module. Press pair, wait until device asks to enter pairing password, type: "5555" (as in the example on the **Figure 24**). Paired device will show up in the paired device list. Download a terminal for Bluetooth e.g. *BlueTerm* from *Play Store/App store*. Run app, click **Find->Connect** to your paired device. Now we need to send a command to GH5200 from Bluetooth terminal, type: ".log:1". Device will respond with "Debug enabled" and GH5200 log will show up. Do not forget to save the log file to mobile phone.

5.12.4 Device debug over Android smartphone

In order to pair FMB device with Android smartphone, make sure that BT radio is enabled (visible) in device configuration. It can be checked via SMS command too:

getparam 800

General	
BT Radio	
Disable	Enable (hidden)
Enable (visible)	
Local Name	GH5200_6500351
Local PIN	5555
Security Mode	
PIN only	PIN + MAC list
MAC list only	None

The answer has to be **2**, which means *Enabled (visible)*.

- Scan for visible BT devices using your Android smartphone and connect to your GH5200 device.

Default GH5200 BT name is: ***GH5200_last_7_imei_digits***

Default PIN code is: ***5555***

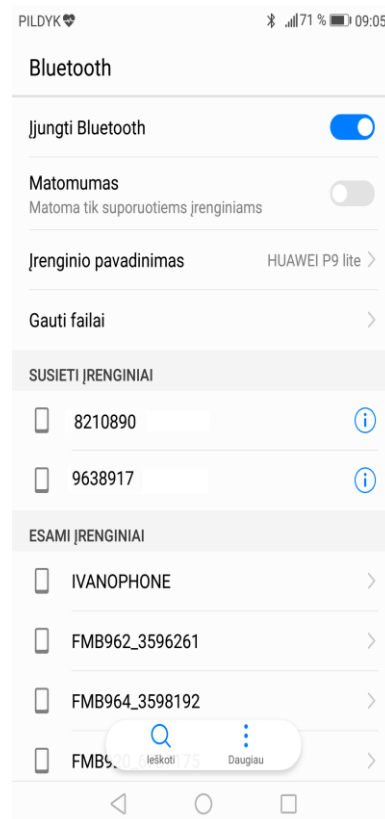

- Download *Bluetooth Terminal* application. Following link can be used:
<https://play.google.com/store/apps/details?id=com.hatflabs.btt>
- Run *Bluetooth Terminal*. In menu press **Connect** button and select paired GH5200 device. To start log check **CR** and enter the command into terminal: **.log:1**

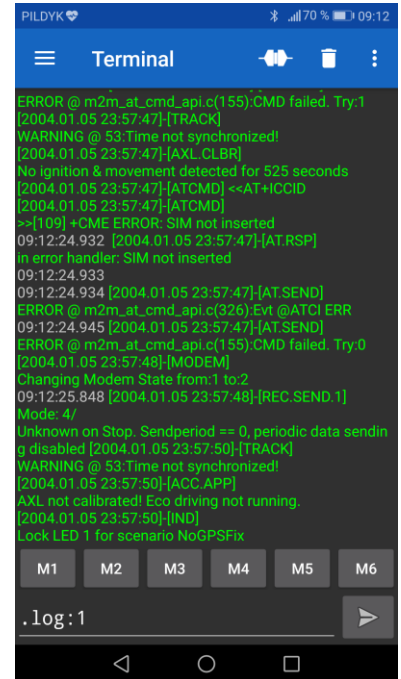

Wait ~10 minutes and press **Save** button in menu. You will find the saved log file in device folder **My Files/Bluetooth Terminal**, select log files, press **Share via Email** and send them to Teltonika support.

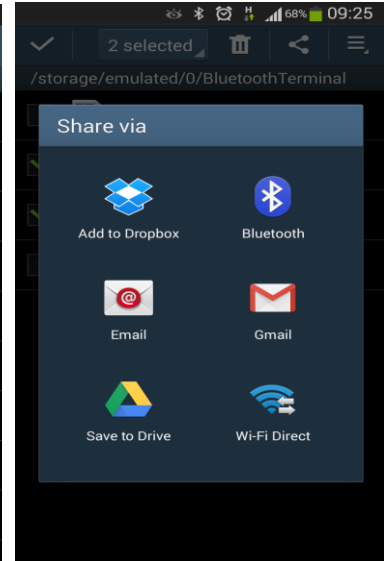
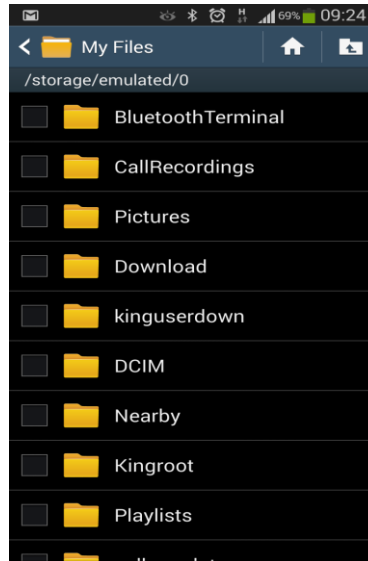
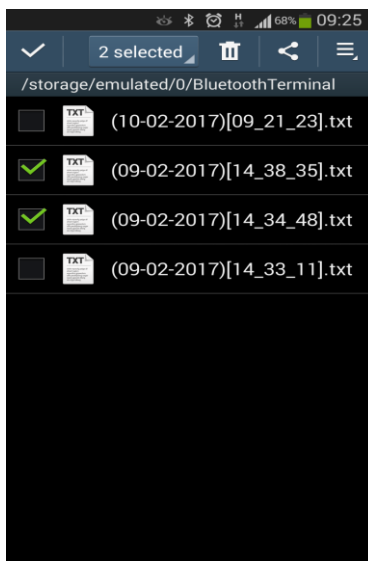

Note: Unfortunately, it is not possible to perform debug the same way on iPhone, because there is no native SPP Bluetooth profile support on iPhone.

5.13 SMS events

SMS events functionality allows GH5200 to send a configured SMS when an event is triggered. This event can be triggered by every I/O element.

When any of the I/O elements is triggered, GH5200 sends a configured SMS message to a defined phone number. If SMS events are activated but there are no numbers defined in *GSM Predefined Numbers* list (similarly as in **Figure 26**), then the device will not send any messages.

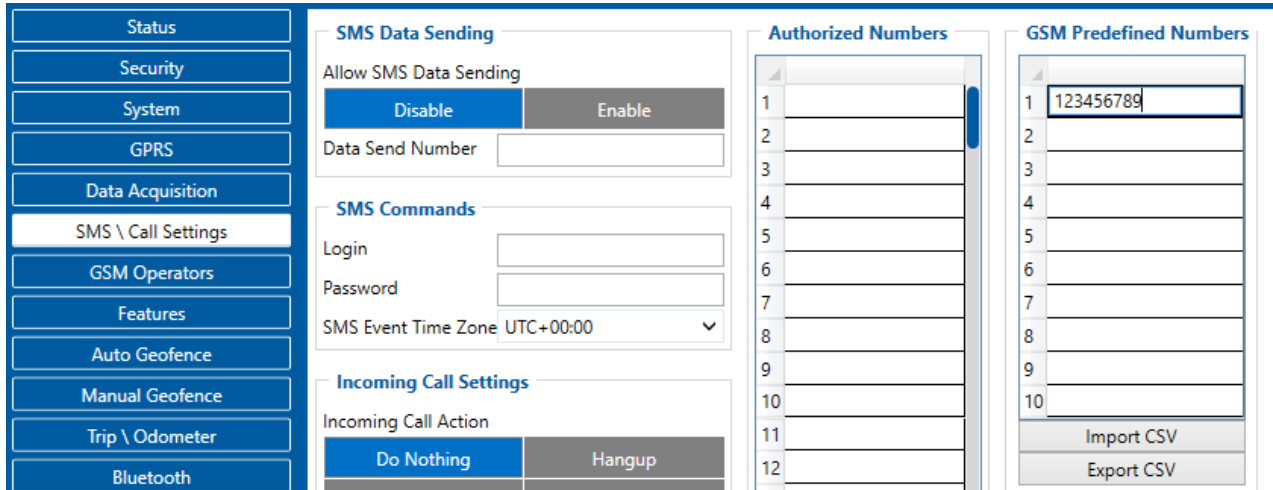

Figure 27 GSM PreDefined Numbers list

The sent SMS messages format is following:

“Date Time Current Coordinate Event Text”

For example, if GH5200 is configured to send an SMS, when Movement reaches high level while configured with *High priority* and event generation on both range entrance and exit (as **Figure 27**), then the sent SMS is:

“2017/06/13 13:52:18 Lon:25.255537 Lat:54.667193 Movement 1”

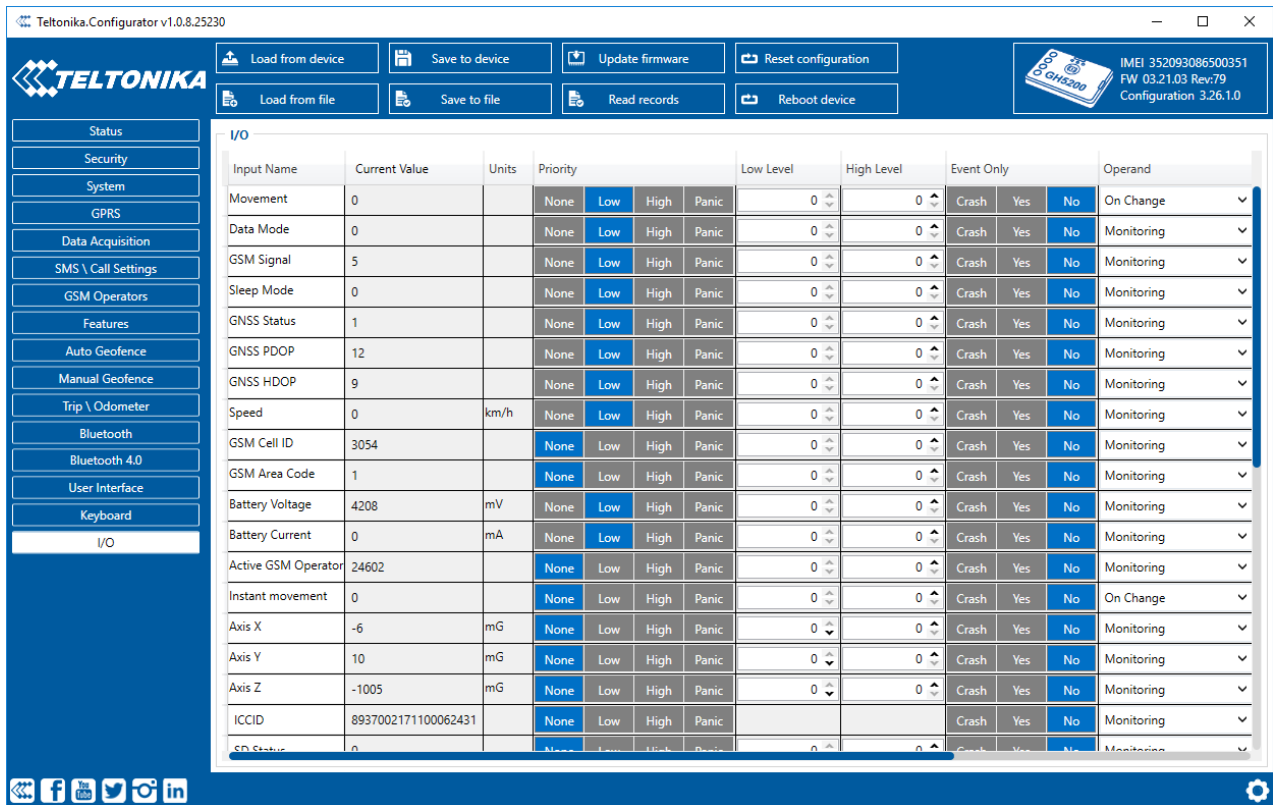

Figure 28 Configured Movement SMS event

5.14 SMS Text

The SMS Text field can be altered and any text can be entered. Maximum message length is 160 symbols (numbers, letters and symbols in ASCII, except for comma symbol ",").

SMS Event Text may be either in default or composed format.

Default format:

Date, time, longitude, latitude, 'SMS text', value

Example:

2018/11/02 12:00:00 Lon:0.000000 Lat:0.000000 Alarm 1

Composed format:

Composed format may consist of text and defined commands which start with % symbol.

Supported commands:

Command	Description
imei	Device IMEI
fw	Firmware version
fullfw	Full Firmware version

Command	Description
modem	Modem Firmware version
gnss	GPS Firmware version
lat	Latitude (non-float value)
lon	Longitude (non-float value)
sat	Satellites in use
time	Timestamp
pdp	PDOP
hdp	HDOP
mov	Movement
op	GSM Operator
spd	Speed
sig	GSM Signal
slp	Sleep Mode
cel	Cell ID
lac	Area Code
datetime	Time in hh:mm:ss format
val	Eventual IO value
lo'par_id'	Element value by parameter ID
gmap	Google Maps link

Composed text example:

```
%imei Movement %io50010
```

Event SMS text:

```
352094082828606 Movement 1
```



ATTENTION!

If GH5200 is in *Deep Sleep* mode and an SMS event occurs with *Low* priority (which does not wake up GH5200), then the device does not send the message. It is saved to device memory until it wakes up from *Deep Sleep* mode and GSM modem starts working normally. After it wakes up, all the messages that are saved to memory will be sent, but keep in mind that only 10 messages can be saved to memory – all other messages will not be saved, until there is free memory space.

5.15 I/O settings

When no I/O element is enabled, AVL packet comes with GNSS information only. After enabling I/O element(s) AVL packet contains current value(s) of enabled I/O element(s) along with GNSS information.

If the device is connected to configurator all current I/O values are displayed in *Current Value* column.

Priority field allows enabling I/O elements and setting them a priority so they are added to the data packet, which is sent to the server. By default 8 I/O elements with low priority are enabled: *Movement, Data Mode, GSM Signal, Sleep Mode, GNSS Status, GNSS PDOP, GNSS HDOP* and *Battery Voltage*. Priority level (AVL packet priority) can be *Low, High* or *Panic*. All records made by GH5200 are regular, and regular packets are sent as low priority records. When *Low priority* event is triggered, GH5200 makes an additional record with an indication that the event was caused by an I/O element change (depending on *Operand* configuration). When *High priority* is selected, module makes an additional record with high priority flag and sends event packet immediately to the server using GPRS. *Panic priority* triggers same actions as *High priority*, but if GPRS fails, it sends an AVL packet using SMS data if SMS data sending is enabled and the number is provided in **SMS/Call Settings**.

High and *Low* levels define I/O value range. If I/O value enters or exits this range, GH5200 generates an event. Operand parameter defines when to generate event: *On Exit, On Entrance, On Both, On Hysteresis* or *On Delta Change*.

When *Event Only* is selected, I/O element status value will be appended only to eventual records, otherwise I/O element status value will appear in each AVL record.

5.15.1 Operand On Exit

Record is generated when input value leaves a range between low and high level limits.

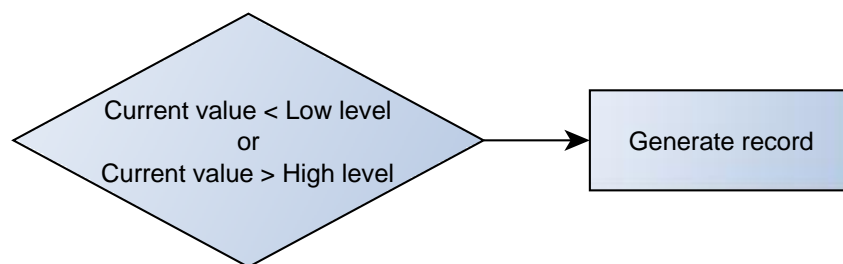

Figure 29 On Exit operand logic

5.15.2 Operand On Entrance

Record is generated when input value enters a range between low and high level limits.

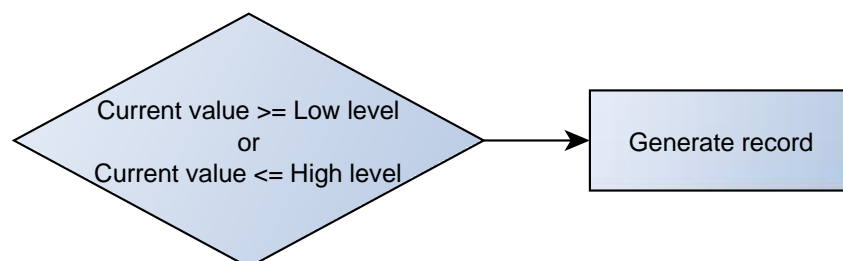

Figure 30 On Entrance operand logic

5.15.3 Operand On Both

Record is generated by both *On Exit* and *On Entrance* operands' logic at same time.

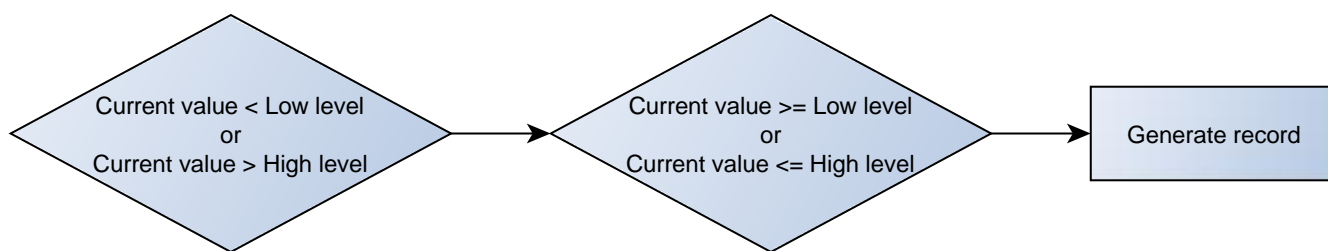

Figure 31 On Both operand logic

5.15.4 Operand Monitoring

No event at all. Values are recorded only when other triggers worked.

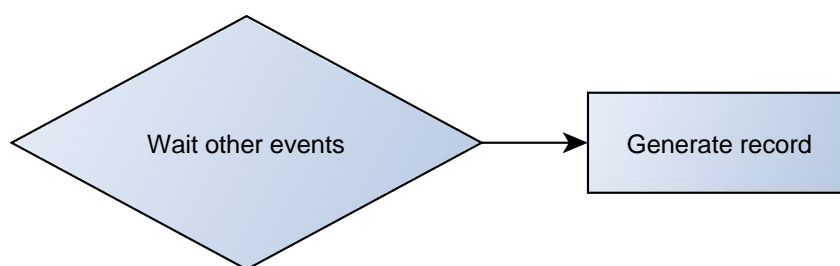

Figure 32 Monitoring operand logic

5.15.5 Operand On Hysteresis

Record is generated when input value crosses the high limit value from below the low limit value or vice versa.

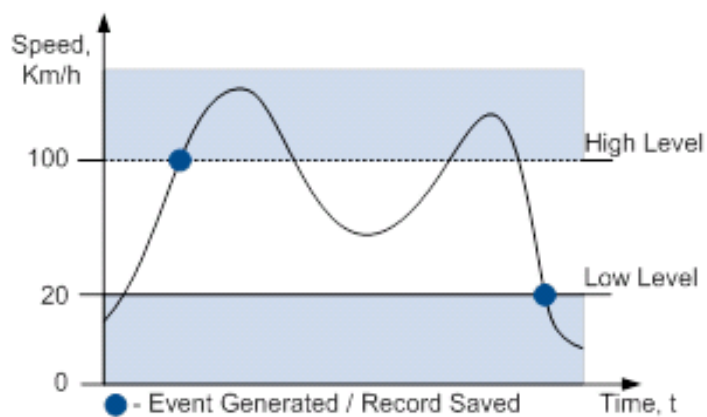

Figure 33 Hysteresis operand logic

5.15.6 Operand On Change

Record is generated when input value changes.

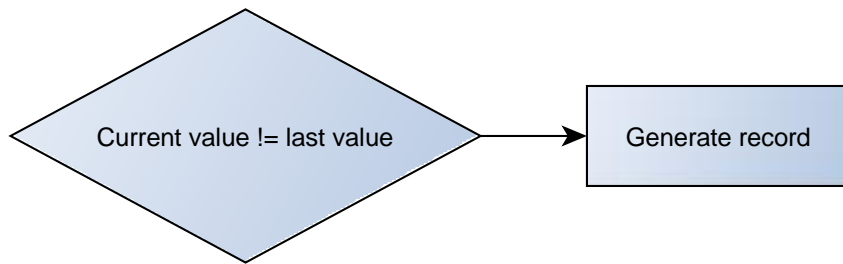

Figure 34 On change operand logic

5.15.7 Operand On Delta Change

Record is generated when input value changes and the absolute change becomes equal to or higher than the limit value.

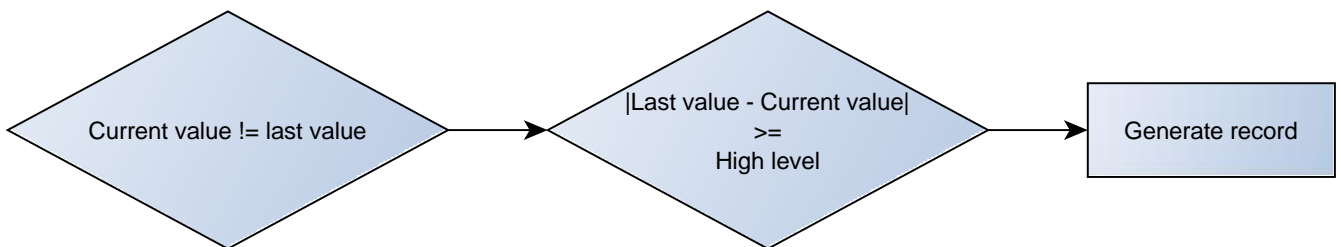

Figure 35 On Delta Change operand logic

5.15.8 Avg const (Averaging parameter description)

If *Avg Const* value is 10, new value must be present for 1 second to register the change to a new value. Internal sampling is done every 40 ms, so 25 samples are taken per second. To configure 5 seconds of averaging multiply 10 by 5 yielding 50 as *Avg Const* value. The same logic works if the device is in Deep Sleep mode.

Averaging follows RC exponential curve, see image below:

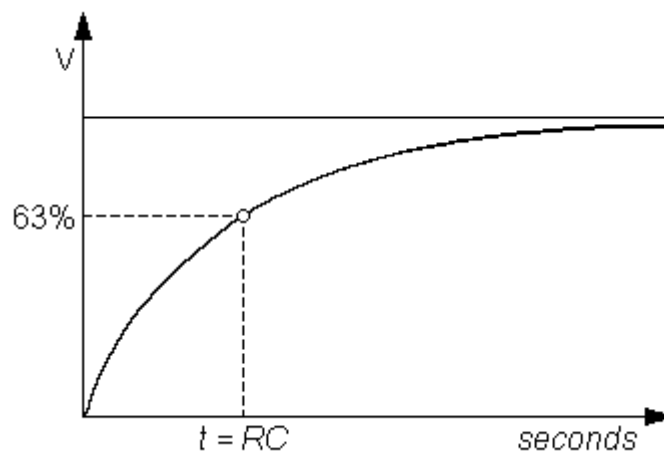

Figure 36 Averaging counting explanation

For Boolean values 5 π , values is used, that means value change is taken when new values is averaged to more then 99.3%.

5.16 User Interface

Indication is configurable in **User Interface** tab of configurator or via

Features ParametersID. Each 100 ms device checks if any indication is enabled in response to triggered scenarios. If two scenarios need to indicate on the same indication source (*LED* or *Vibration*) then the active indicating scenario needs to be finished first (with exception of *Alarm*, *Power Key Pressed* and *Device Off* scenarios, which can override the control of indication sources). An example of indication configuration is given in the picture shown below. Period setting is indicative of *Periodic* scenarios (refer to the table below) and if *Period* is set to 0 the indication will take place immediately. When indication is periodic and *On* parameter value is set to 0, the indication source will stay on until the scenario is finished. Triggered scenarios will turn on LED and/or vibration for a configured *On* duration and then keep them off for a configured *Off* period of time. In case the configured Repeat value is higher than 0 the device continues a periodic on/off cycle.

Name	Type	Trigger Reason
GSM Error	On event	SIM is not inserted, blocked, failed to connect to an operator or jammed
GSM Signal Established	On event	Register to GSM network
SMS Send/Received	On event	SMS is being received or sent
Incoming Call	On event	Incoming call is in process
Call Active	On event	Call is in process
Outgoing Call	On event	Outgoing call is in process
Remote Connection	On event	Device is connected to the server
Event	On event	An event record is saved
Panic Event	On event	A panic event record is saved
No GPS Fix	Periodic	Device tries to obtain valid GPS fix
GPS Fix	Periodic	Device has valid GPS fix
Device Off	On event	Device is turning off
Device On	On event	Device is turning on

Name	Type	Trigger Reason
Key Pressed	Periodic	Any button is pressed
Keyboard Activated	Action	On event
Keyboard Deactivated	Action	On event
Charging	Periodic	Device is charging
Fully Charged	Periodic	Device is fully charged
Charging Error	On event	Device stops charging while being connected to power supply
Pre Alarm	Periodic	ManDown functionality starts counting down to an event
Sleep Mode	Periodic	Device is in sleep mode
I Am Alive	Periodic	Indication about turned on device
ManDown	Periodic	Man-down in enabled
Battery Low	Periodic	Low battery

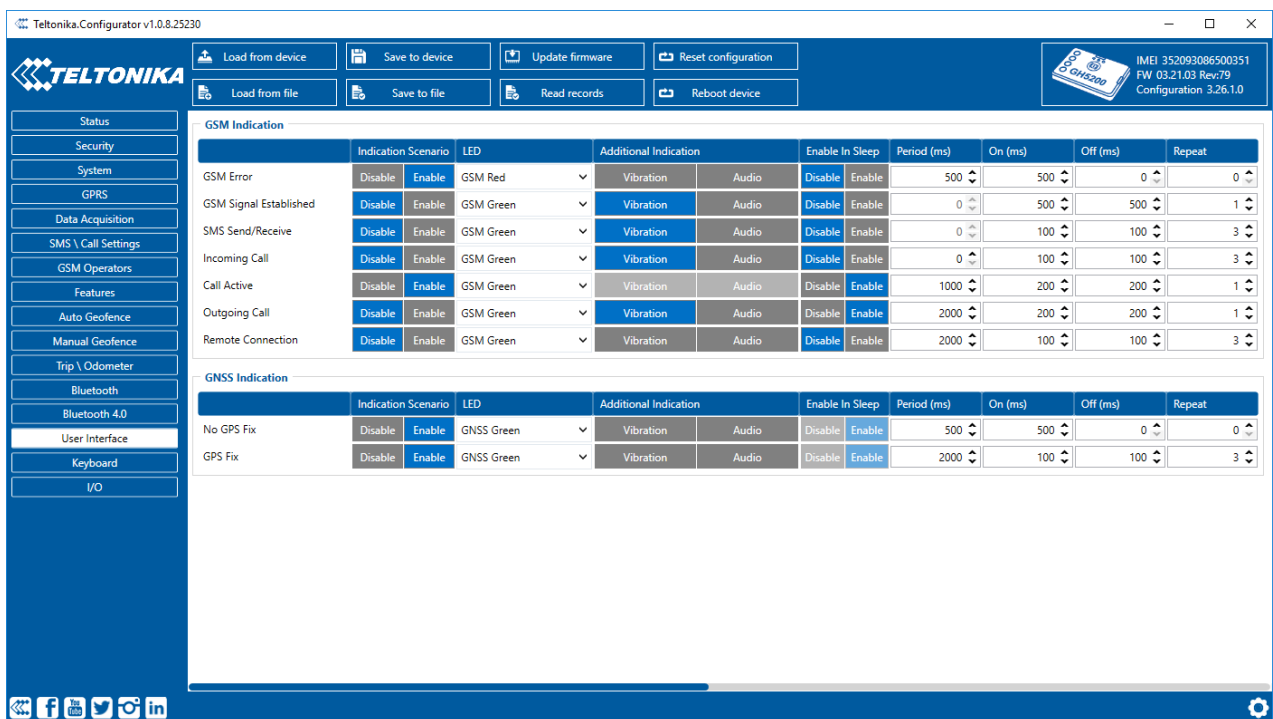

Figure 37 Indication settings

There are two types of indications: periodic and on event. Periodic indications are indicating each configured period and on event time indications are indicating only one time. All indications are described in tables below. Indication can be configured in User Settings via configurator or via SMS/GPRS commands using parameter ID.

Parameter ID	Name	Configuration values		
		Min	Max	Description
P+0	Enable	0	1	Enables or disables scenario
P+1	Enable In Sleep	0	1	0 – Disabled 1 – Enabled
P+2	LED	0	3	0 – Battery Red 1 – Battery Green 2 – GSM Red 3 – GSM Green 4 – GNSS Red 5 – GNSS Green 6 – None
P+3	Additional Indication	0	3	0 – None 1 – Vibration 2 – Audio 3 – Vibration and Audio
P+4	Period	0	3600000	Period in milliseconds
P+5	On	0	10000	Time in ms
P+6	Off	0	10000	Time in ms
P+7	Repeat	0	100	Repeat count of On-Off Cycle

P – Parameter ID of indication scenario described.

Indication works like this. Each 100 ms device checks if any indication is enabled and triggered. If indication is enabled and triggered then it starts. If other scenario has to be indicated on the same LED, vibration or audio, then it has to wait while active scenario finishes, only if indication has higher priority then indication with lower priority will be canceled.

“Enable In Sleep” indications. This parameter allows to disable or enable indication, when device is in Deep Sleep, Online Deep Sleep or Ultra Deep Sleep modes. When “Low Power Mode” is configured, then “Enable In Sleep” parameter has no effect and indications are allowed if they is enabled.

It is possible to configure indication’s LED, Vibration, Audio, Period, On, Off and Repeat. When period is set to 0, then indication will start immediately to indicate with configured resources. Indication will turn LED and Vibration on for configured ON timeout and play audio signal that is 100 ms long. After this timeout resources are turned off and indication waits for configured OFF timeout. When Off timeout exceeds, then device checks into Repeat configuration, if it is higher then 0, then indication repeats On/Off cycle for configured repeats, if it is 0, then indication is finished and indication will start on the next period, when indication is periodic. To set LED, vibration and audio to work permanently, indications ON timeout has to be set to 0. The resources will be freed only when scenario is canceled or higher priority indication starts executing. Permanent audio is using 100 ms long sound signal, then 100 ms pause. All configuration by parameter ID is in table above.

When one of keyboard indications is triggered other indications will be suspended.

Indication scenarios, indication description and default settings:

Par ID	Name	Trigger Reason	Parameters default values				LED
			Enable	Enable In Sleep	Vibration	Audio	
14000	GSM Error	When SIM not inserted, is blocked, failed to connect to operator or jammed	1	0	0	0	GSM Red
14010	GSM signal established	When device is registered to home or roaming network	0	0	0	0	GSM Green
14020	SMS Send/Received	When SMS is received or sent	0	0	1	0	GSM Green
14030	Incoming Call	When there is incoming call	0	0	1	0	GSM Green
14040	Remote Connection	When device is connected to server	0	0	0	0	GSM Green
14050	Event	When eventual record is saved	0	0	0	0	GNSS Green
14060	Panic Event	When panic record is saved	0	0	0	0	GNSS Red
14070	No GPS Fix	When device searches valid GPS fix	1	0	0	0	GNSS Green
14080	GPS Fix	When device has valid GPS fix	1	0	0	0	GNSS Green
14090	Device Off	When device is turning off	1	-	1	1	Battery Green
14100	Device ON	When device turns on	1	-	1	1	Battery Green
14110	Key Pressed	When device button is pressed	0	-	0	0	Battery Green
14130	Keyboard Action Activated	Button was triggered with configured function to activate functionality	0	-	1	0	GNSS Green
14140	Keyboard Action Deactivated	Button was triggered with configured function to deactivate functionality	0	-	1	0	GNSS Green
14150	Charging	When device is charging	1	-	0	0	Battery Green
14160	Fully Charged	When device is fully charged	1	-	0	0	Battery Green
14170	Pre Alarm	When ManDown functionality starts counting timeout till event.	0	-	1	1	GNSS Red
14180	Sleep Mode	When device is in sleep mode	0	1	0	0	GNSS Green
14190	I Am Alive	When configured period passes	1	0	0	0	GNSS Green
14200	Battery Error	When charger connected and device is in critical temperature mode. Device enters this mode after termo shutdown, which is executed when temperature exceeds 65 °C temperature.	1	-	0	0	Battery Red
14210	Termo Shutdown	When temperature exceeds 65 °C	1	-	1	0	Battery Red
14220	Low Battery	When battery level is less of equal configured low battery level (12)	1	-	0	0	Battery Red
14230	Charger Error	When somethings wrong happens while charging and charger is disabled forcefully	1	-	0	0	Battery Red
14240	Outgoing Call	Not yet implemented	0	-	1	0	GNSS Green

Par ID	Name	Trigger Reason	Parameters default values				
			Enable	Enable In Sleep	Vibration	Audio	LED
14280	First Function	When button is hold for configured timeout for detecting first function	1	-	0	1	Battery Green
14290	Second Function	When button is hold for configured timeout for detecting second function	1	-	0	1	GSM Green
14300	Function Detective	When button is hold for configured timeout for deactivation	1	-	0	1	GNSS Green
14310	Call Active	When Voice call is in progress	1	1	0	0	GSM Green
14320	ManDown	When ManDown event is generated	0	1	0	0	GSM Green

5.17 Keyboard

A virtual keyboard is based on five buttons: *Alarm Button*, 1, 2, 3 and *Power Button*. Each button has three click combinations and one *Power Button*-specific combination for power off:

- *1 Click* – button is pressed once for no longer than two seconds.
- *Clicks* – button is pressed for no more than two times. Time between clicks has to be shorter than one second.
- *Long Click* – button in pressed and held down for two seconds.
- *5 second-long click on Power Button* - the device is turned off.

Figure 38 Keyboard settings

Name	Trigger Reason
------	----------------

None	Do nothing when button is triggered
Alarm	Activate Alarm scenario
ManDown On	Enable ManDown scenario
ManDown Off	Disable ManDown scenario
ManDown Switch	Activate/Deactivate ManDown scenario
Auto Geofence On	Enable Auto Geofence scenario
Auto Geofence Off	Disables Auto Geofence scenario
Auto Geofence Switch	Activate/Deactivate Auto Geofence scenario
Call	Initiates a call to the number selected in <i>Call table</i>
SMS	Send an SMS to the number selected in <i>SMS table</i>
Tracking On	Enable GNSS tracking
Tracking Off	Disables GNSS tracking
Tracking Switch	Enables/Disables GPS tracking
Movement Event On	Enables movement scenario
Movement Event Off	Disables movement scenario
Movement Event Switch	Enables/Disables movement scenario
Answer	Answer an incoming call in normal mode
Loud Answer	Answer an incoming call in Loudspeaker mode
Hang-Up	Hang-up incoming/outgoing call
Volume Up	Increase active voice call volume
Volume Down	Decrease active voice call volume
Switch Speaker	Enable/Disable Loudspeaker mode
Power Off	Turn off device

There is no restriction for configuring the same action for all button's combinations.

6 SMS/GPRS COMMAND LIST²

All commands are case sensitive. When user tries to send SMS/GPRS message to GH5200 that operates in Deep Sleep mode, it cannot arrive to GH5200 device because the GSM/GPRS module is disabled most of the time. GH5200 will receive the SMS/GPRS message when it exits Deep Sleep mode. If GH5200 is in GPS Sleep or Online Deep Sleep mode, sent SMS/GPRS message will arrive to the device.

6.1 SMS/GPRS command list

Table 4. Common SMS/GPRS commands

2 GPRS commands require Codec 12 protocol

Command	Description	Response
getinfo	Returns device runtime system information	Yes
getver	Returns code version, device IMEI, modem app version, RTC time, Init time, Uptime and BT MAC address	Yes
getstatus	Returns modem status information	Yes
getgps	Returns current GPS data, date and time	Yes
getio	Reads out analog input, digital input and output	Yes
ggps	Returns location information with Google maps link	Yes
readio #	Returns IO status, # AVL ID	Yes
cpureset	Resets the device	No
getparam #	Returns selected parameter value, # param ID	Yes
setparam #:#	Sets selected parameter value 1.# - first ID value	Yes
setparam #:#;#:#;...	2.# - New first Parameter Value 3.# - second ID value 4.# - New second Parameter Value 5.# - third ID value 6.# - New third Parameter Value SMS command is limited to 160 characters	
flush #,#,#,#,#,#,#	Redirects device to other server 1.# - IMEI 2.# - APN 3.# - LOGIN 4.# - PASS 5.# - IP 6.# - PORT 7.# - MODE (0-TCP/1-UDP)	Yes
countrecs	Returns records number	Yes
deleterecords	Deletes all records from SD card	Yes
battery	Returns battery state info	Yes
wdlog	Returns all information about <i>watchdog</i> restarts	Yes
defaultcfg	Loads default configuration	Yes
setkey # #	Adds a new configuration keyword or changes the current one. If device is locked, keyword cannot be changed 1.# - old keyword 2.# - new keyword	Yes
delkey #	Removes existing keyword (If the device is locked, the keyword cannot be changed) # - old keyword	Yes
bbread #	Returns black box information (HEX value of event ID and HEX value of custom data field (optional)). 1.# - returns entered number of latest events. When # is omitted the latest events are packed into a single	Yes

Command	Description	Response
	SMS message	
bbinfo #	Returns the same information as bbread command but additionally all events timestamps are written in HEX. 1.# - returns entered number of latest events. When # is omitted the latest events are packed into a single SMS message	Yes
sdformat	Formats NAND	Yes

Table 5. SMS commands related to Bluetooth

Command	Description	Response
btgetlist #	Returns requested Bluetooth list # - 0,1 or 2 (0 – Discovered, 1 – Paired, 2 – Connected)	Yes
btscan	Starts Bluetooth scan	Yes
btvisible #	Sets Bluetooth to visible with TMO # - visibility TMO (from 1 to 255 seconds).	Yes
btrelease #	Disconnects from current device and pauses auto connect functionality for a TMO duration # - none or TMO (from 1 to 255 seconds).	Yes
btunpair #	Unpairs Bluetooth device # - all, BT address (all – unpair all devices, BT address – unpair only specified MAC address)	Yes

Parameter ID consists of 3 or 5 digits. Detailed list of parameters and IDs can be found in Parameter list.

For example: **'username password setparam 2001:wap'** will change configured APN.

As another example: **'username password setparam 2001:wap;2002:user;2003:pass'** will change configured APN name, APN username and APN password. SMS command is limited to 160 characters.

6.1.1 getinfo

Response details	Description
RTC	RTC Time
Init	Device initialization time
UpTime	Total up time (in seconds)
PWR	Last restart reason
RST	Total restarts count
GPS	GPS receiver state. 0 – OFF, 1 – ON without fix, 2 – ON with fix, 3 – In sleep mode.
SAT	Average satellites
TTFF	Time To First Fix
TTLF	Time To Last Fix
NOGPS	How much time no GPS fix (h:min)
SR	Number of Sent Records

Response details	Description
FG	Failed GPRS counter
FL	Failed link counter
SMS	Sent SMS Counter
REC	Records Found – number of records stored in the memory
MD	Data Mode state. 0 – Home and Stop, 1 – Home and Moving, 2 – Roaming and Stop, 3 – Roaming and Moving, 4 – Unknown and Stop, 5 – Unknown and Moving

Example: "RTC:2017/6/16 7:13 Init:2017/6/16 5:44 UpTime:4744s PWR:PwrVoltage RST:0 GPS:1 SAT:0 TTFF:0 TTLF:0 NOGPS: 1:18 SR:0 FG:200 FL:0 SMS:3 REC:42 MD:1".

6.1.2 getver

Response details	Description
Ver	Firmware version
GPS	Version of GPS module
Hw	Version of hardware
Mod	HW version modification
IMEI	Device IMEI
Init	Device initialization time
Uptime	Total up time (in seconds)
BT	Device MAC address

Example: "Ver:02.00.01_06 GPS:AXN_3.80_3333_16070400,0000,, Hw:GH5200 Mod:4 IMEI:352094082042885 Init: 2017-6-16 5:54 Uptime: 16574 BT:31F5BFE66261".

6.1.3 getstatus

Response details	Description
Data Link	Indicates module connection to server at the moment: 0 – Not connected, 1 – Connected
GPRS	Indicates if GPRS is available at the moment
Phone	Voice Call status: 0 – Ready, 1 – Unavailable, 2 – Unknown, 3 – Ringing, 4 – Call in progress, 5 – Asleep
SIM	SIM Status: 0 – Ready, 1 – PIN, 2 – PUK, 3 – PIN2, 4 – PUK2
OP	When connected to GSM Operator: numerical ID of operator
Signal	GSM Signal Quality [0-5]
NewSMS	Indicates if new message has been received
Roaming	0 – Home Network, 1 – Roaming
SMSFull	Indicates whether SMS storage is full. 0 – OK, 1 – SMS storage is full
LAC	GSM Tower Location Area Code
Cell ID	GSM Tower Cell ID Code

Example: "Data Link: 0 GPRS: 1 Phone: 0 SIM: 0 OP: 24602 Signal: 5 NewSMS: 0 Roaming: 0 SMSFull: 0 LAC: 1 Cell ID: 3055".

6.1.4 getgps

Response details	Description
------------------	-------------

Response details	Description
GPS	Indicates valid (1) or invalid (0) Gps data
Sat	Provides currently available satellites' count
Lat	Latitude (Last good Latitude)
Long	Longitude (Last good Longitude)
Alt	Altitude
Speed	Ground speed, km/h
Dir	Ground direction, degrees
Date	Current date
Time	Current GMT time

Example: "GPS:1 Sat:0 Lat:54.666042 Long:25.225031 Alt:0 Speed:0 Dir:0 Date: 2017/6/16 Time: 12:52:30".

6.1.5 ggps

Response details	Description
D	Date
T	Time
S	Actual Speed
C	Latitude (Last good Latitude), Longitude (Last good Longitude)
Url	Google Maps Link

Example (if no GNSS FIX): "GPS Data not Available. No GPS signal".

Example: D:17/1/9 T:12:52:30 S:0.00 C:54.666042, 25.225032 Url: <http://maps.google.com/?q=54.666042,25.225032&om=1speed:0>

6.1.6 getparam

Reads parameter value for given ID that consists of 3 or 5 digits. A detailed list of parameters and identifiers can be found in the following chapter.

For example: **getparam 2001** command will request APN name.

Example answer: Param ID:2001 Value:wap

6.1.7 setparam

Reads parameter value for a given ID that consists of 3 or 5 digits. A detailed list of parameters and identifiers can be found in the following chapter.

For example: **setparam 2001:wap** will change configured APN name.

Answer: Param ID:2001 Value:wap2

Another example: **setparam 2001:wap;2002:user;2003:pass** will change configured APN name, APN username and APN password. SMS command of limited to 160 characters.

6.1.8 flush #,#,#,#,#,#

Initiates all data transfer by GPRS to a specified target server. Comma separated parameters go in following order:

- 1.# - IMEI
- 2.# - APN
- 3.# - GPRS LOGIN
- 4.# - GPRS PASSWORD

- 5.# - IP
- 6.# - PORT
- 7.# - MODE (0 – TCP/1 – UDP)

Parameters are separated by comma (no spaces needed). In case you do not need to enter parameter (APN Login/ APN Pass) – do not use space, simply enter comma and write next parameter.

Example: opa opa flush 353976012555151,banga,,,212.47.99.62,12050,0

Response details	Description
FLUSH SMS Accepted	FLUSH SMS Accepted
# records found on FLASH	Number of records found on FLASH
Minimum Records to Send: #	Number of minimum saved records to send
GPRS Enabled: #	State of the GPRS connection: 0 – Disabled; 1 – Enabled
Time Sync: #	Indicates time synchronization on the device: 0 – Not synchronized; 1 – Synchronized

Example: "FLUSH SMS Accepted. 11 records found on FLASH. Minimum Records to Send: 1. GPRS Enabled: 1. Time Sync: 1."

6.1.9 countrecs

Returns current number of records stored in the device memory.

Example (if more than 100): "more than 100 records found"

Example: "25 records found"

6.1.10 deleterecords

Deletes all records from the device memory.

6.1.11 battery

Response details	Description
BatState	Battery connected (1) or disconnected (0) from device
FSMState	Current battery state
ChargerIC	Battery charging status
ExtV	External Voltage
BatV	Battery voltage
BatI	Battery charging current

Example: "BatState: 1 FSMState: ACTIVE ChargerIC: OFF ExtV: 11796 BatV: 3942 BatI: 0"

6.1.12 btgetlist

btgetlist command needs argument what list should be printed!

btgetlist 0; device will respond with BT_LIST_Discovered.

btgetlist 1; device will respond with all paired devices.

btgetlist 2; device will respond with connected bluetooth device.



Note: Without argument it is always 0 i.e **BT_LIST_Discovered**. In FW 01.00.23 btgetlist (without args) will not respond (as unknown command).

6.1.13 setkey #

"setkey <oldkeyword> <newkeyword>" - Set new or change the keyword. Configuration should be not locked.

Example: New keyword (set)

<name>{space}<pass>{space}setkey{space}{space}<newkeyword>

Another example: Change keyword (change)

<name>{space}<pass>{space}setkey{space}<oldkeyword>{space}<newkeyword>

6.1.14 delkey #

"delkey <keyword>" - Deletes current keyword. Configuration keyword should be configured and not locked.

Example: <name>{space}<pass>{space}delkey{space}<keyword>

6.1.15 bbread

describes start offset and is an optional field. For example, value of 20 means that blackbox data is requested starting from 20th latest event. When # is omitted the most recent events are packet into a single SMS.

Example: X1:Y1,X2:Y2,...,Xn:Yn, where Xn – HEX value of event ID. Yn – HEX value of custom data field (optional).

6.1.16 bbinfo

describes start offset and is an optional field. For example, value of 20 means that blackbox data is requested starting from 20th latest event. When # is omitted the most recent events are packet into a single SMS.

Example: X1-Y1:Z1,X2-Y2:Z2,...,Xn-Yn:Zn, where Xn – timestamp in HEX. Yn – HEX value of event ID. Zn – HEX value of custom data field (optional).

6.1.17 sdfORMAT

Format device memory (deletes all information from device memory).

7 PARAMETER LIST

7.1 System parameters

7.1.1 Sleep Mode (ID=102)

Device has three sleep modes: GPS sleep, Deep Sleep and Online Deep Sleep mode. When sleep is disabled (value 0) module will never enter sleep mode, in sleep mode (value 1) module reduces level of power usage by turning GPS module to sleep, in deep sleep mode (value 2) module turns GPS module to sleep and device is deregistered from network (note, that GH5200 do not receive SMS when in deep sleep), online Deep Sleep mode (value 3) device works as in Deep Sleep mode, but without deregistering from GSM network. GSM part stays powered, so this increases power consumption. In this mode, device should received/send SMS and make/receive calls. Also not closes GPRS context, if previously opened.

Minimum value	Maximum value	Default value	Goes with (depends on) parameters	Value type
0	4	2	Sleep timeout (ID=103)	Uint8

7.1.2 Sleep timeout (ID=103)

Sleep timeout is time after which GH5200 goes into GPS sleep, Deep Sleep or Online Deep Sleep if other requirements are met. Its parameter is set in minutes.

Minimum value	Maximum value	Default value	Goes with (depends on) parameters	Value type
1	3000	10	Sleep Mode (ID=102)	Uint8

7.1.3 Static Navigation (ID=106)

When static navigation is enabled, GH5200 filters out GPS jumps, when it is not moving. When it is disabled, it does not make any changes to collected GPS data.

Minimum value	Maximum value	Default value	Goes with (depends on) parameters	Value type
0	1	1		Uint8

7.1.4 Saving/Sending without time synchronization (ID=107)

When this feature is enabled (value = 1), then records can be saved and sent to server without time synchronization.

Minimum value	Maximum value	Default value	Goes with (depends on) parameters	Value type
0	2	0		Uint8

7.1.5 GNSS Source (ID=109)

This parameter sets satellite system(s), available values are:

0 – Undefined	5 – Galileo + BeiDou	10 – GPS + GLONASS	14 – GPS + Galileo + GLONASS
1 – BeiDou only	6 – Galileo + GLONASS	12 – GPS + Galileo	
2 – GLONASS only		13 – GPS + Galileo + BeiDou	15 – GPS, Galileo, GLONASS and BeiDou and not allowed
3 – Galileo + BeiDou	8 – GPS only		
4 – Galileo only	9 – GPS + BeiDou		

Minimum value	Maximum value	Default value	Goes with (depends on) parameters	Value type
0	15	10		Uint8

7.1.6 Synchronization settings (ID=900)

Sets the source used for device internal time synchronization: 0 – GPS only; 1 – NITZ and NTP; 2 – NTP; 3 – NITZ.

Minimum value	Maximum value	Default value	Goes with (depends on) parameters	Value type
0	3	1	NTP Resync (ID=901) NTP server 1 (ID=902) NTP server 2 (ID=903)	Uint8

7.1.7 NTP Resync (ID=901)

Periodical time synchronization parameter. GH5200 will resynchronize once set period (not 0) expires.

Minimum value	Maximum value	Default value	Goes with (depends on) parameters	Value type
0	24	0	Synchronization settings (ID=900) NTP server 1 (ID=902) NTP server 2 (ID=903)	Uint8

7.1.8 NTP server 1 (ID=902)

Minimum value	Maximum value	Default value	Goes with (depends on) parameters	Value type
0	55 char string	av1.teltonika.lt	Synchronization settings (ID=900) NTP Resync (ID=901) NTP server 2 (ID=903)	S8[55]

7.1.9 NTP server 2 (ID=903)

Minimum value	Maximum value	Default value	Goes with (depends on) parameters	Value type
0	55 char string	pool.ntp.org	Synchronization settings (ID=900) NTP Resync (ID=901) NTP server 1 (ID=902)	S8[55]

7.2 GPRS parameters

7.2.1 Sorting (ID=1002)

Record sorting parameter is responsible for record sorting order. Value of 0 results in arranging data starting from newest record, another option is to sort by oldest record.

Minimum value	Maximum value	Default value	Goes with (depends on) parameters	Value type
0	1	0	Open Link Timeout (ID=1000) Server Response Timeout (ID=1001)	Uint8

7.2.2 Open Link Timeout (ID=1000)

Defines how many seconds device will keep connection to the server after successful data transfer while waiting for a new record.

Minimum value	Maximum value	Default value	Goes with (depends on) parameters	Value type
30	259200	30	Sorting (ID=1002) Server Response Timeout (ID=1001)	Uint32

7.2.3 Server Response Timeout (ID=1001)

Defines time period in seconds for server response to sent records.

Minimum value	Maximum value	Default value	Goes with (depends on) parameters	Value type
5	300	30	Sorting (ID=1002) Open Link Timeout (ID=1000)	Uint16



ATTENTION! Some GSM operators may disconnect the device from an active data link if the device does not send any data for a very long duration, even if the active data link timeout is set to maximum value. The amount of time that an operator keeps the link open depends solely on the operator. For example, if active data link timeout is set to maximum of 259200 seconds (72 hours) and the device sends data to server every 86400 seconds (24 hours), the operator might disconnect the link earlier and the device will have to connect to the server again. This may cost extra, depending on the operator GPRS data charges. When using active data link timeout, it is strongly recommended that data sending to the server is not rare (24 hours or less).

7.2.4 SIM GPRS content activation (ID=2000)

Parameter allows or does not allow GPRS usage with SIM, value of 0 disallows GPRS.

Minimum value	Maximum value	Default value	Goes with (depends on) parameters	Value type
0	1	1	SIM APN Name (ID=2001) SIM SIM APN Username (ID=2002) SIM SIM APN Password (ID=2003)	Uint8

7.2.5 SIM APN Name (ID=2001)

Parameter defines SIM GPRS Access Point Name.

Minimum value	Maximum value	Default value	Goes with (depends on) parameters	Value type
0	32 char string	Empty	SIM SIM GPRS content activation (ID=2000) SIM SIM APN Username (ID=2002) SIM SIM APN Password (ID=2003)	S8[32]

7.2.6 SIM APN Username (ID=2002)

Parameter defines SIM APN username. In case operator does not use username for login, value should be empty.

Minimum value	Maximum value	Default value	Goes with (depends on) parameters	Value type
0	30 char string	Empty	SIM GPRS content activation (ID=2000) SIM APN Name (ID=2001) SIM APN Password (ID=2003)	S8[30]

7.2.7 SIM APN Password (ID=2003)

Parameter defines SIM APN password. In case operator does not use password for login, value should be empty.

Minimum value	Maximum value	Default value	Goes with (depends on) parameters	Value type
0	30 char string	Empty	SIM GPRS content activation (ID=2000) SIM APN Name (ID=2001) SIM APN Username (ID=2002)	S8[30]

7.2.8 Domain (ID=2004)

Parameter defines data destination server IP address. *Example: 212.47.99.62*

Minimum value	Maximum value	Default value	Goes with (depends on) parameters	Value type
0	55 char string	Empty	SIM GPRS content activation (ID=2000)	S8[55]

7.2.9 Target Server Port (ID=2005)

Parameter defines data destination server port number. *Example: 12050*

Minimum value	Maximum value	Default value	Goes with (depends on) parameters	Value type
0	65535	0	SIM GPRS content activation (ID=2000)	Uint16

7.2.10 Protocol (ID=2006)

Parameter defines GPRS data transport protocol. Module can use TCP or UDP transport protocol to send data to the server. For TCP protocol use value of 0, for UDP protocol value is 1.

Minimum value	Maximum value	Default value	Goes with (depends on) parameters	Value type
0	1	0	SIM GPRS content activation (ID=2000)	Uint8

7.2.11 Backup Server Domain (ID=2007)

This parameter defines data destination backup server IP address. *Example: 212.47.99.61*

Minimum value	Maximum value	Default value	Goes with (depends on) parameters	Value type
0	55 char string	Empty	SIM GPRS content activation (ID=2000) Backup Server Mode (ID=2010)	S8[55]

7.2.12 Backup Server Port (ID=2008)

Parameter defines data destination backup server port number. *Example: 12051*

Minimum value	Maximum value	Default value	Goes with (depends on) parameters	Value type
0	65535	0	SIM GPRS content activation (ID=2000) Backup Server Mode (ID=2010)	Uint16

7.2.13 Backup Server Protocol (ID=2009)

Parameter defines GPRS data transport protocol. Module can use TCP or UDP transport protocol to send data to backup server. For TCP protocol use 0, for UDP protocol value is 1.

Minimum value	Maximum value	Default value	Goes with (depends on) parameters	Value type
0	1	0	SIM GPRS content activation (ID=2000) Backup Server Mode (ID=2010)	Uint8

7.2.14 Backup Server Mode (ID=2010)

Sets backup server mode: 0 – Disable (backup server not used); 1 – Backup (sent to backup server if main server not available); 2 – Duplicate (send records to both servers).

Minimum value	Maximum value	Default value	Goes with (depends on) parameters	Value type
0	2	0	SIM GPRS content activation (ID=2000)	Uint8

7.2.15 FOTA WEB status (ID=13003)

This parameter allows or disallows connection to FOTA WEB server.

Minimum value	Maximum value	Default value	Goes with (depends on) parameters	Value type
0	1	1	FOTA WEB Domain (ID=13000) FOTA WEB port (ID=13001) FOTA WEB Period (min) (ID=13002)	Uin8

7.2.16 FOTA WEB Domain (ID=13000)

FOTA WEB server IP or DNS address.

Minimum value	Maximum value	Default value	Goes with (depends on) parameters	Value type
0	55 char string	85.206.140.106	FOTA WEB status (ID=13003) FOTA WEB port (ID=13001) FOTA WEB Period (min) (ID=13002)	S8[55]

7.2.17 FOTA WEB port (ID=13001)

FOTA WEB server port.

Minimum value	Maximum value	Default value	Goes with (depends on) parameters	Value type
0	65535	5000	FOTA WEB status (ID=13003) FOTA WEB Domain (ID=13000) FOTA WEB Period (min) (ID=13002)	Uin16

7.2.18 FOTA WEB Period (min) (ID=13002)

This parameter defines how often device connects to the server.

Minimum value	Maximum value	Default value	Goes with (depends on) parameters	Value type
30	65535	720	FOTA WEB status (ID=13003) FOTA WEB Domain (ID=13000) FOTA WEB port (ID=13001)	Uin16

7.3 SMS/Call settings

7.3.1 SMS data sending settings (ID=3000)

Parameter controls sending AVL data using binary SMS. It is equal to 1 when it is allowed.

Minimum value	Maximum value	Default value	Goes with (depends on) parameters	Value type
0	1	0	Data send number (ID=3001)	Uin8

7.3.2 Data send number (ID=3001)

This parameter defines a GSM number which is ready to receive Data SMS.

Minimum value	Maximum value	Default value	Goes with (depends on) parameters	Value type
Empty	16 digits	-	SMS data sending settings (ID=3000)	S8[16]

7.3.3 Authorized phone numbers (ID=4000-4199)

If at least one number is entered then only those number can send messages to device.

Example: +37060012346

Minimum value	Maximum value	Default value	Goes with (depends on) parameters	Value type
Empty	16 digits	-	SMS Login (ID=3003) SMS Password (ID=3004)	S8[16]

7.3.4 GSM Predefined Numbers (ID=6000-6009)

These IDs contain GSM numbers, which are used to send “Event SMS” text messages.

Example: +37060012346

Minimum value	Maximum value	Default value	Goes with (depends on) parameters	Value type
Empty	16 digits	-	Over Speeding Send SMS To (ID=7032) AutoGeofence Send SMS to (ID=7030) Send SMS to #1-5 Geozone (ID=7025-7029), #6-50 Geozone (ID=7071-7115) Alarm send SMS to (ID=7245) ManDown Send SMS (ID=7222) I/O#1 send SMS (ID=7000)	S8[16]

7.3.5 SMS Login (ID=3003)

User login is used to ensure module security. Used in every SMS that is sent to device.

Example: ba321

Minimum value	Maximum value	Default value	Goes with (depends on) parameters	Value type
Empty	5 char	-	SMS Password (ID=3004) SMS Event Time Zone (ID=3006)	S8[5]

7.3.6 SMS Password (ID=3004)

User password is used to ensure module security. Used in every SMS that is sent to device.

Example: ab123

Minimum value	Maximum value	Default value	Goes with (depends on) parameters	Value type
Empty	5 char	-	SMS Login (ID=3003) SMS Event Time Zone (ID=3006)	S8[5]

7.3.7 Incoming call action (ID=3005)

This parameter defines the device’s response to a call: 0 - Do nothing (BT HF); 1 - Hang up; 2 - Report position; 3 - Auto Answer (HF); 4 – SPY; 5 – ManDown; 6 - Info SMS; 7 - Power Off; 8 - Send GPRS Data; 9 - Auto Geofence Off.

Minimum value	Maximum value	Default value	Goes with (depends on) parameters	Value type
0	9	0		Uint8

7.3.8 SMS Event Time Zone (ID=3006)

Time zone which will be used in event SMS messages.

Minimum value	Maximum value	Default value	Goes with (depends on) parameters	Value type
-720	840	0	SMS Password (ID=3004) SMS Login (ID=3003)	Uint16

7.3.9 Detect Number Type By Plus Symbol (ID=4999)

When enabled, numbers with “+” symbols will be used as international and numbers without it - as local/unknown. 0 – Disable; 1 – Enable.

Minimum value	Maximum value	Default value	Goes with (depends on) parameters	Value type
0	10	0	Authorized Numbers (ID=4000-4199) GSM Predefined Numbers (ID=6000-6009)	Uint8

7.4 GSM Operators

7.4.1 SIM Roaming Operator List (ID=5000-5049)

This parameter list defines a roaming operator list for SIM. An operating profile is selected according to this list. If roaming operator list is left empty, GH5200 will automatically detect a home operator. If home operator is written to any part of the roaming operator list, it will still be detected as a home operator. All other written operators are Preferred Roaming Operator Codes. More information about operator search functionality can be found in [GSM Operators Roaming and Blacklist Operator list](#).

Minimum value	Maximum value	Default value	Goes with (depends on) parameters	Value type
0	999999	0	Black List (ID=5500-5549)	Uint32

7.4.2 Black List (ID=5500-5549)

If it is required that GH5200 does not connect to a particular operator it must be written to the Operator BlackList. Refer to [GSM Operators Roaming and Blacklist Operator list](#) for more information.

Minimum value	Maximum value	Default value	Goes with (depends on) parameters	Value type
0	999999	0	Roaming Operator List (ID=5000-5049)	Uint32

7.5 Data Acquisition Modes parameters

7.5.1 Home Network GSM operator code “Vehicle on STOP” parameters

7.5.1.1 Min Period (ID=10000)

This parameter indicates time interval in seconds in order to acquire a new record. If value is 0 it means no records by min period will be saved.

Minimum value	Maximum value	Default value	Goes with (depends on) parameters	Value type
0	2592000	3600	Min Saved Records (ID=10004) Send Period (ID=10005)	Uint32

7.5.1.2 Min Saved Records (ID=10004)

This parameter defines minimum number of records in one data packet that can be sent to server. It has higher priority than Data Send Period (ID=10005).

Minimum value	Maximum value	Default value	Goes with (depends on) parameters	Value type
1	255	1	Min Period (ID=10000) Send Period (ID=10005)	Uint8

7.5.1.3 Send Period (ID=10005)

This parameter indicates frequency (time interval in seconds) of sending data to server.

Minimum value	Maximum value	Default value	Goes with (depends on) parameters	Value type
0	2592000	120	Min Period (ID=10000) Min Saved Records (ID=10004)	Uint32

7.5.2 Home Network GSM operator code “Vehicle MOVING” parameters

7.5.2.1 Min Period (ID=10050)

This parameter indicates time interval in seconds in order to acquire a new record. If value is 0 no records by min period will be saved.

Minimum value	Maximum value	Default value	Goes with (depends on) parameters	Value type
0	2592000	300	Min Distance (ID=10051) Min Angle (ID=10052) Min Speed Delta (ID=10053) Min Saved Records (ID=10054) Send Period (ID=10055)	Uint32

7.5.2.2 Min Distance (ID=10051)

This parameter indicates distance in meters in order to acquire a new record. Record is stored when the distance between previous records is greater than parameter’s value. If value is 0 it means no records by min distance will be saved.

Minimum value	Maximum value	Default value	Goes with (depends on) parameters	Value type
0	65535	100	Min Period (ID=10050) Min Angle (ID=10052) Min Speed Delta (ID=10053) Min Saved Records (ID=10054) Send Period (ID=10055)	Uint16

7.5.2.3 Min Angle (ID=10052)

This parameter indicates angle in degrees in order to acquire a new record. If angle difference between last recorded coordinate and current position is greater than defined value, new record is stored. This parameter is operational, when speed is higher than 10km/h. If value is 0 it means no records by min angle will be saved.

Minimum value	Maximum value	Default value	Goes with (depends on) parameters	Value type
0	180	10	Min Period (ID=10050) Min Distance (ID=10051) Min Speed Delta (ID=10053) Min Saved Records (ID=10054) Send Period (ID=10055)	Uint8

7.5.2.4 Min Speed Delta (ID=10053)

This parameter indicates speed difference in order to acquire a new record. If speed difference between last recorded coordinate and current position is greater than defined value, new record is stored. If value is 0 it means no records by min speed delta will be saved.

Minimum value	Maximum value	Default value	Goes with (depends on) parameters	Value type
0	255	10	Min Period (ID=10050) Min Distance (ID=10051) Min Angle (ID=10052) Min Saved Records (ID=10054) Send Period (ID=10055)	Uint8

7.5.2.5 Min Saved Records (ID=10054)

This parameter defines minimum number of records in one data packet that can be sent to server. It has higher priority than Data Send Period (ID=10055).

Minimum value	Maximum value	Default value	Goes with (depends on) parameters	Value type
1	255	1	Min Period (ID=10050) Min Distance (ID=10051) Min Angle (ID=10052) Min Speed Delta (ID=10053) Send Period (ID=10055)	Uint8

7.5.2.6 Send Period (ID=10055)

This parameter indicates frequency (time interval in seconds) of sending data to server.

Minimum value	Maximum value	Default value	Goes with (depends on) parameters	Value type
0	2592000	120	Min Period (ID=10050) Min Distance (ID=10051) Min Angle (ID=10052) Min Speed Delta (ID=10053) Min Saved Records (ID=10054)	Uint32

7.5.3 Roaming Network GSM operator code “Vehicle on STOP” parameters

7.5.3.1 Min Period (ID=10100)

This parameter indicates time interval in seconds in order to acquire a new record. If value is 0 it means no records by min period will be saved.

Minimum value	Maximum value	Default value	Goes with (depends on) parameters	Value type
0	2592000	3600	Min Saved Records (ID=10104) Send Period (ID=10105)	Uint32

7.5.3.2 Min Saved Records (ID=10104)

This parameter defines minimum number of records in one data packet that can be sent to server. It has higher priority than Data Send Period (ID=10105).

Minimum value	Maximum value	Default value	Goes with (depends on) parameters	Value type
1	255	1	Min Period (ID=10100) Send Period (ID=10105)	Uint8

7.5.3.3 Send Period (ID=10105)

This parameter indicates frequency (time interval in seconds) of sending data to server.

Minimum value	Maximum value	Default value	Goes with (depends on) parameters	Value type
0	2592000	120	Min Period (ID=10100) Min Saved Records (ID=10104)	Uint32

7.5.4 Roaming Network GSM operator code “Vehicle MOVING” parameters

7.5.4.1 Min Period (ID=10150)

This parameter indicates time interval in seconds in order to acquire a new record. If value is 0 it means no records by min period will be saved.

Minimum value	Maximum value	Default value	Goes with (depends on) parameters	Value type
0	2592000	300	Min Distance (ID=10151) Min Angle (ID=10152)	Uint32

			Min Speed Delta (ID=10153) Min Saved Records (ID=10154) Send Period (ID=10155)	
--	--	--	--	--

7.5.4.2 Min Distance (ID=10151)

This parameter indicates distance in meters in order to acquire a new record. Record is stored when the distance between previous records is greater than parameter's value. If value is 0 it means no records by min distance will be saved.

Minimum value	Maximum value	Default value	Goes with (depends on) parameters	Value type
0	65535	100	Min Period (ID=10150) Min Angle (ID=10152) Min Speed Delta (ID=10153) Min Saved Records (ID=10154) Send Period (ID=10155)	Uint16

7.5.4.3 Min Angle (ID=10152)

This parameter indicates angle in degrees in order to acquire a new record. If angle difference between last recorded coordinate and current position is greater than defined value, new record is stored. This parameter is operational, when speed is higher than 10km/h. If value is 0 it means no records by min angle will be saved.

Minimum value	Maximum value	Default value	Goes with (depends on) parameters	Value type
0	180	10	Min Period (ID=10150) Min Distance (ID=10151) Min Speed Delta (ID=10153) Min Saved Records (ID=10154) Send Period (ID=10155)	Uint8

7.5.4.4 Min Speed Delta (ID=10153)

This parameter indicates speed difference in order to acquire a new record. If speed difference between last recorded coordinate and current position is greater than defined value, new record is stored. If value is 0 it means no records by min speed delta will be saved.

Minimum value	Maximum value	Default value	Goes with (depends on) parameters	Value type
0	255	10	Min Period (ID=10150) Min Distance (ID=10151) Min Angle (ID=10152) Min Saved Records (ID=10154) Send Period (ID=10155)	Uint8

7.5.4.5 Min Saved Records (ID=10154)

This parameter defines minimum number of records in one data packet that can be sent to server. It has higher priority than Data Send Period (ID=10105).

Minimum value	Maximum value	Default value	Goes with (depends on) parameters	Value type
1	255	1	Min Period (ID=10150)	Uint8

Minimum value	Maximum value	Default value	Goes with (depends on) parameters	Value type
			Min Distance (ID=10151) Min Angle (ID=10152) Min Speed Delta (ID=10153) Send Period (ID=10155)	

7.5.4.6 Send Period (ID=10155)

This parameter indicates frequency (time interval in seconds) of sending data to server.

Minimum value	Maximum value	Default value	Goes with (depends on) parameters	Value type
0	2592000	120	Min Period (ID=10150) Min Distance (ID=10151) Min Angle (ID=10152) Min Speed Delta (ID=10153) Min Saved Records (ID=10154)	Uint32

7.5.5 Unknown Network GSM operator code “Vehicle on STOP” parameters

7.5.5.1 Min Period (ID=10200)

This parameter indicates time interval in seconds in order to acquire a new record. If value is 0 it means no records by min period will be saved.

Minimum value	Maximum value	Default value	Goes with (depends on) parameters	Value type
0	2592000	3600	Min Saved Records (ID=10204) Send Period (ID=10205)	Uint32

7.5.5.2 Min Saved Records (ID=10204)

This parameter defines minimum number of records in one data packet that can be sent to server. It has higher priority than Data Send Period (ID=10205).

Minimum value	Maximum value	Default value	Goes with (depends on) parameters	Value type
1	255	1	Min Period (ID=10200) Send Period (ID=10205)	Uint8

7.5.5.3 Send Period (ID=10205)

This parameter indicates frequency (time interval in seconds) of sending data to server.

Minimum value	Maximum value	Default value	Goes with (depends on) parameters	Value type
0	2592000	120	Min Period (ID=10200) Min Saved Records (ID=10204)	Uint32

7.5.6 Unknown Network GSM operator code “Vehicle MOVING” parameters

7.5.6.1 Min Period (ID=10250)

This parameter indicates time interval in seconds in order to acquire a new record. If value is 0 it means no records by min period will be saved.

Minimum value	Maximum value	Default value	Goes with (depends on) parameters	Value type
0	2592000	300	Min Distance (ID=10251) Min Angle (ID=10252) Min Speed (ID=10253) Min Saved Records (ID=10254) Send Period (ID=10255)	Uint32

7.5.6.2 Min Distance (ID=10251)

This parameter indicates distance in meters in order to acquire a new record. Record is stored when the distance between previous records is greater than parameter’s value. If value is 0 it means no records by min distance will be saved.

Minimum value	Maximum value	Default value	Goes with (depends on) parameters	Value type
0	65535	100	Min Period (ID=10250) Min Angle (ID=10252) Min Speed (ID=10253) Min Saved Records (ID=10254) Send Period (ID=10255)	Uint16

7.5.6.3 Min Angle (ID=10252)

This parameter indicates angle in degrees in order to acquire a new record. If angle difference between last recorded coordinate and current position is greater than defined value, new record is stored. This parameter is operational, when speed is higher than 10km/h. If value is 0 it means no records by min angle will be saved.

Minimum value	Maximum value	Default value	Goes with (depends on) parameters	Value type
0	180	10	Min Period (ID=10250) Min Distance (ID=10251) Min Speed (ID=10253) Min Saved Records (ID=10254) Send Period (ID=10255)	Uint8

7.5.6.4 Min Speed (ID=10253)

This parameter indicates speed difference in order to acquire a new record. If speed difference between last recorded coordinate and current position is greater than defined value, new record is stored. If value is 0 it means no records by min speed delta will be saved.

Minimum value	Maximum value	Default value	Goes with (depends on) parameters	Value type
0	255	10	Min Period (ID=10250) Min Distance (ID=10251)	Uint8

			Min Angle (ID=10252) Min Saved Records (ID=10254) Send Period (ID=10255)	
--	--	--	--	--

7.5.6.5 Min Saved Records (ID=10254)

This parameter defines minimum number of records in one data packet that can be sent to server. It has higher priority than Data Send Period (ID=10105).

Minimum value	Maximum value	Default value	Goes with (depends on) parameters	Value type
1	255	1	Min Period (ID=10250) Min Distance (ID=10251) Min Angle (ID=10252) Min Speed (ID=10253) Send Period (ID=10255)	Uint8

7.5.6.6 Send Period (ID=10255)

This parameter indicates frequency (time interval in seconds) of sending data to server.

Minimum value	Maximum value	Default value	Goes with (depends on) parameters	Value type
0	2592000	120	Min Period (ID=10250) Min Distance (ID=10251) Min Angle (ID=10252) Min Speed (ID=10253) Min Saved Records (ID=10254)	Uint32

7.6 Features Parameters

7.6.1 Alarm

7.6.1.1 Scenario Settings (ID=11710)

Scenario: 0 – Disabled; 1 – Enable.

Minimum value	Maximum value	Default value	Goes with (depends on) parameters	Value type
0	1	0	GSM Predefined Numbers (ID=6000-6009)	Uint8

7.6.1.2 Send SMS To (ID=7245)

Enables/disables SMS. 0 – Disable; 1-10 – SMS will be sent to configured GSM number.

Minimum value	Maximum value	Default value	Goes with (depends on) parameters	Value type
0	10	0	GSM Predefined Numbers (ID=6000-6009)	Uint8

7.6.1.3 SMS Text (ID=8245)

Configures alarm SMS event text.

Minimum value	Maximum value	Default value	Goes with (depends on) parameters	Value type
0	160 char	Alarm		S8[160]

7.6.1.4 Call Settings (ID=11711)

Scenario: 0 – Disabled; 1 – Enable.

Minimum value	Maximum value	Default value	Goes with (depends on) parameters	Value type
0	1	0	GSM Predefined Numbers (ID=6000-6009)	UInt8

7.6.1.5 Call to (ID=11712)

Enables/disables the call event. 0 – Disable; 1-10 – SMS will be sent to configured GSM number.

Minimum value	Maximum value	Default value	Goes with (depends on) parameters	Value type
0	10	0	GSM Predefined Numbers (ID=6000-6009)	UInt8

7.6.2 Overspeeding scenario parameters

7.6.2.1 Overspeeding priority (ID=11100)

Defines priority of overspeeding scenario: 0 – Disabled; 1 – Low; 2 – High; 3 – Panic.

Minimum value	Maximum value	Default value	Goes with (depends on) parameters	Value type
0	3	0	Max allowed Speed (ID=11104) Over Speeding Send SMS To (ID=7032) Over Speeding SMS Text (ID=8032)	UInt8

7.6.2.2 Max Speed (ID=11104)

Maximum allowed speed, an event will occur when this value is exceeded.

Minimum value	Maximum value	Default value	Goes with (depends on) parameters	Value type
0	260	90	Overspeeding priority (ID=11100) Over Speeding Send SMS To (ID=7032) Over Speeding SMS Text (ID=8032)	UInt16

7.6.2.3 Overspeeding Send SMS To (ID=7032)

Enables/disables SMS. 0 – Disable; 1-10 – SMS will be sent to configured GSM number.

Minimum value	Maximum value	Default value	Goes with (depends on) parameters	Value type
0	10	0	Overspeeding priority (ID=11100) Max allowed Speed (ID=11104)	UInt8

			Over Speeding SMS Text (ID=8032) GSM Predefined Numbers (ID=6000-6009)	
--	--	--	--	--

7.6.2.4 Overspeeding SMS Text (ID=8032)

Configures over speeding SMS event text.

Minimum value	Maximum value	Default value	Goes with (depends on) parameters	Value type
0	160 char	Overspeeding	Overspeeding priority (ID=11100) Max allowed Speed (ID=11104) Over Speeding Send SMS To (ID=7032)	S8[160]

7.6.3 ManDown scenario parameters

7.6.3.1 Scenario Settings (ID=12100)

Scenario settings: 0 – Disable; 1 – Enable.

Minimum value	Maximum value	Default value	Goes with (depends on) parameters	Value type
0	1	0		Uint8

7.6.3.2 Position (ID=12100)

0 – Horizontal; 1 – Vertical.

Minimum value	Maximum value	Default value	Goes with (depends on) parameters	Value type
0	1	0		Uint8

7.6.3.3 Angle (ID=12102)

Angle in degrees from 30 to 150.

Minimum value	Maximum value	Default value	Goes with (depends on) parameters	Value type
30	150	60		Uint8

7.6.3.4 Timeout (ID=12103)

Timeout in seconds before ManDown is detected.

Minimum value	Maximum value	Default value	Goes with (depends on) parameters	Value type
0	65500	3		Uint16

7.6.3.5 Send SMS To (ID=7222)

Enable/disable SMS. 0 – Disable; 1-10 – SMS will be sent to configured GSM number.

Minimum value	Maximum value	Default value	Goes with (depends on) parameters	Value type
0	10	0	GSM Predefined Numbers (ID=6000-6009)	Int32

7.6.3.6 SMS Text (ID=8222)

Configures ManDown SMS event text.

Minimum value	Maximum value	Default value	Goes with (depends on) parameters	Value type
0	160 char	ManDown	GSM Predefined Numbers (ID=6000-6009)	S8[160]

7.6.3.7 Call Settings (ID=12104)

Sets time period, that DOUT will be on.

Minimum value	Maximum value	Default value	Goes with (depends on) parameters	Value type
0	1	0	Eventual records (ID=11701) Send SMS to (ID=7140) SMS text (ID=8140)	Uint8

7.6.3.8 Call to (ID=12105)

Enables/disables call. 0 – Disable; 1-10 – SMS will be sent to a configured GSM number.

Minimum value	Maximum value	Default value	Goes with (depends on) parameters	Value type
0	10	0	GSM Predefined Numbers (ID=6000-6009)	Uint8

7.7 AutoGeofencing scenario parameters

7.7.1 AutoGeofencing priority (ID=20000)

Defines priority of autogeofencing scenario:

0 – Disabled; 1 – Low; 2 – High; 3 – Panic.

Minimum value	Maximum value	Default value	Goes with (depends on) parameters	Value type
0	3	0	Eventual Records (ID=20002) AutoGeofence event generating (ID=20001) Radius (ID=20004) Send SMS to (ID=7030) SMS Text (ID=8030)	Uint8

7.7.2 Eventual Records (ID=20002)

0 – Disabled, include parameter to all records; 1 – Enabled, include parameter to record only if event was generated.

Minimum value	Maximum value	Default value	Goes with (depends on) parameters	Value type
0	1	1	AutoGeofencing priority (ID=20000) AutoGeofence event generating	Uint8

			(ID=20001) Radius (ID=20004) Send SMS to (ID=7030) SMS Text (ID=8030)	
--	--	--	--	--

7.7.3 AutoGeofence event generating (ID=20001)

Generate event: 0 – On exiting zone; 1 – On entering zone; 2 – On both.

Minimum value	Maximum value	Default value	Goes with (depends on) parameters	Value type
0	2	0	AutoGeofencing priority (ID=20000) Eventual Records (ID=20002) Radius (ID=20004) Send SMS to (ID=7030) SMS Text (ID=8030)	Uint8

7.7.4 Radius (ID=20004)

This parameter represents the radius of a circle with device coordinates after activating AutoGeofence feature.

Minimum value	Maximum value	Default value	Goes with (depends on) parameters	Value type
0	1000000	100	AutoGeofencing priority (ID=20000) Eventual Records (ID=20002) AutoGeofence event generating (ID=20001) Send SMS to (ID=7030) SMS Text (ID=8030)	Uint32

7.7.5 AutoGeofence Send SMS to (ID=7030)

Enables/disables SMS. 0 – Disable; 1-10 – SMS will be sent to configured GSM number.

Minimum value	Maximum value	Default value	Goes with (depends on) parameters	Value type
0	10	0	AutoGeofencing priority (ID=20000) Eventual Records (ID=20002) AutoGeofence event generating (ID=20001) Radius (ID=20004) SMS Text (ID=8030) GSM Predefined Numbers (ID=6000-6009)	Uint64

7.7.6 SMS Text (ID=8030)

Configures AutoGeofence SMS event text.

Minimum value	Maximum value	Default value	Goes with (depends on) parameters	Value type
0	160	AutoGeofence	AutoGeofencing priority (ID=20000) Eventual Records (ID=20002) AutoGeofence event generating (ID=20001) Radius (ID=20004) Send SMS to (ID=7030)	S8[180]

7.7.7 Call Settings (ID=12104)

Sets time period, that DOUT will be on.

Minimum value	Maximum value	Default value	Goes with (depends on) parameters	Value type
0	1	0	Eventual records (ID=11701) Send SMS to (ID=7140) SMS text (ID=8140)	Uint8

7.7.8 Call to (ID=12105)

Enables/disables call. 0 – Disable; 1-10 – SMS will be sent to configured GSM number.

Minimum value	Maximum value	Default value	Goes with (depends on) parameters	Value type
0	10	0	GSM Predefined Numbers (ID=6000-6009)	Uint8

7.8 Manual Geofence

7.8.1 First Geozone parameters

An example of first Geozone parameters is given here. All 50 geozones are configured with a similar logic.

7.8.1.1 #1 Geozone Manual Geofencing priority (ID=20100):

0 – Disabled; 1 – Low; 2 – High; 3 – Panic.

Minimum value	Maximum value	Default value	Goes with (depends on) parameters	Value type
0	3	0	#1 Geozone Manual Geofence event generating (ID=20101) #1 Geozone Eventual Records (ID=20102) #1 Geozone Frame border (ID=20103) #1 Geozone Shape type (ID=20104) #1 Geozone Radius (ID=20105) #1 Geozone X1 (ID=20106) #1 Geozone Y1 (ID=20107) #1 Geozone X2 (ID=20108) #1 Geozone X1 (ID=20109)	Uint8

Minimum value	Maximum value	Default value	Goes with (depends on) parameters	Value type
			#1 Geozone OverSpeeding (ID=20110) #1 Geozone Max allowed speed (ID=20111)	

7.8.1.2 #1 Geozone Manual Geofence event generating (ID=20101)

Generate event: 0 – No event; 1 - On exiting zone; 2 – On entering zone; 3 – On both.

Minimum value	Maximum value	Default value	Goes with (depends on) parameters	Value type
0	3	0	#1 Geozone Manual Geofencing priority (ID=20100) #1 Geozone Eventual Records (ID=20102) #1 Geozone Frame border (ID=20103) #1 Geozone Shape type (ID=20104) #1 Geozone Radius (ID=20105) #1 Geozone X1 (ID=20106) #1 Geozone Y1 (ID=20107) #1 Geozone X2 (ID=20108) #1 Geozone X1 (ID=20109) #1 Geozone OverSpeeding (ID=20110) #1 Geozone Max allowed speed (ID=20111)	Uint8

7.8.1.3 #1 Geozone Eventual Records (ID=20102)

0 – Disabled, include parameter to all records; 1 – Enabled, include parameter to record only if event was generated.

Minimum value	Maximum value	Default value	Goes with (depends on) parameters	Value type
0	1	1	#1 Geozone Manual Geofencing priority (ID=20100) #1 Geozone Manual Geofence event generating (ID=20101) #1 Geozone Frame border (ID=20103) #1 Geozone Shape type (ID=20104) #1 Geozone Radius (ID=20105) #1 Geozone X1 (ID=20106) #1 Geozone Y1 (ID=20107) #1 Geozone X2 (ID=20108) #1 Geozone X1 (ID=20109) #1 Geozone OverSpeeding (ID=20110) #1 Geozone Max allowed speed	Uint8

			(ID=20111)	
--	--	--	------------	--

7.8.1.4 #1 Geozone Frame border (ID=20103)

Frame border is an additional border around Geofence zone.

Minimum value	Maximum value	Default value	Goes with (depends on) parameters	Value type
0	1000000	1	#1 Geozone Manual Geofencing priority (ID=20100) #1 Geozone Manual Geofence event generating (ID=20101) #1 Geozone Eventual Records (ID=20102) #1 Geozone Shape type (ID=20104) #1 Geozone Radius (ID=20105) #1 Geozone X1 (ID=20106) #1 Geozone Y1 (ID=20107) #1 Geozone X2 (ID=20108) #1 Geozone X1 (ID=20109) #1 Geozone OverSpeeding (ID=20110) #1 Geozone Max allowed speed (ID=20111)	Uint32

7.8.1.5 #1 Geozone Shape type (ID=20104)

Shape type: 0 – Circle; 1 - Rectangle.

Minimum value	Maximum value	Default value	Goes with (depends on) parameters	Value type
0	1	0	#1 Geozone Manual Geofencing priority (ID=20100) #1 Geozone Manual Geofence event generating (ID=20101) #1 Geozone Eventual Records (ID=20102) #1 Geozone Frame border (ID=20103) #1 Geozone Radius (ID=20105) #1 Geozone X1 (ID=20106) #1 Geozone Y1 (ID=20107) #1 Geozone X2 (ID=20108) #1 Geozone X1 (ID=20109) #1 Geozone OverSpeeding (ID=20110) #1 Geozone Max allowed speed (ID=20111)	Uint8

7.8.1.6 #1 Geozone Radius (ID=20105)

Radius of circle (in metres) when circular zone is used.

Minimum value	Maximum value	Default value	Goes with (depends on) parameters	Value type
5	1000000	5	#1 Geozone Manual Geofencing priority (ID=20100) #1 Geozone Manual Geofence event generating (ID=20101) #1 Geozone Eventual Records (ID=20102) #1 Geozone Frame border (ID=20103) #1 Geozone Shape type (ID=20104) #1 Geozone X1 (ID=20106) #1 Geozone Y1 (ID=20107) #1 Geozone X2 (ID=20108) #1 Geozone X1 (ID=20109) #1 Geozone OverSpeeding (ID=20110) #1 Geozone Max allowed speed (ID=20111)	Uint32

7.8.1.7 #1 Geozone X1 (ID=20106)

Geofence zone left bottom corner X coordinate (longitude).

Minimum value	Maximum value	Default value	Goes with (depends on) parameters	Value type
-180	180	0	#1 Geozone Manual Geofencing priority (ID=20100) #1 Geozone Manual Geofence event generating (ID=20101) #1 Geozone Eventual Records (ID=20102) #1 Geozone Frame border (ID=20103) #1 Geozone Shape type (ID=20104) #1 Geozone Radius (ID=20105) #1 Geozone Y1 (ID=20107) #1 Geozone X2 (ID=20108) #1 Geozone X1 (ID=20109) #1 Geozone OverSpeeding (ID=20110) #1 Geozone Max allowed speed (ID=20111)	Double

7.8.1.8 #1 Geozone Y1 (ID=20107)

Geofence zone left bottom corner Y coordinate (latitude).

Minimum value	Maximum value	Default value	Goes with (depends on) parameters	Value type
-90	90	0	#1 Geozone Manual Geofencing priority (ID=20100) #1 Geozone Manual Geofence event generating (ID=20101) #1 Geozone Eventual Records (ID=20102) #1 Geozone Frame border (ID=20103) #1 Geozone Shape type (ID=20104) #1 Geozone Radius (ID=20105) #1 Geozone X1 (ID=20106) #1 Geozone X2 (ID=20108) #1 Geozone X1 (ID=20109) #1 Geozone OverSpeeding (ID=20110) #1 Geozone Max allowed speed (ID=20111)	Double

7.8.2 Other Geozones

Other Geozone's parameters have a similar logic as given for Geozone #1.

GeoFence Zone Number	Geofence Zone's parameter IDs
1	20100-20111
2	20120-20131
3	20140-20151
...	...
49	21060-21071
50	21080-21091

7.8.2.1 Send SMS to #1-5 Geozone (ID=7025-7029), #6-50 Geozone (ID=7071-7115)
 Enables/disables SMS. 0 – Disable; 1-10 – SMS will be sent to configured GSM number.

Minimum value	Maximum value	Default value	Goes with (depends on) parameters	Value type
0	10	0	GSM Predefined Numbers (ID=6000-6009) SMS Text #1-5 Geozone (ID=8025-8029), #6-50 Geozone (ID=8071-8115)	Uint8

7.8.2.2 SMS Text #1-5 Geozone (ID=8025-8029), #6-50 Geozone (ID=8071-8115)
 Configures geozone # SMS event text.

Minimum value	Maximum value	Default value	Goes with (depends on) parameters	Value type
---------------	---------------	---------------	-----------------------------------	------------

Minimum value	Maximum value	Default value	Goes with (depends on) parameters	Value type
0	160	Geozone Zone #	Send SMS to #1-5 Geozone (ID=7025-7029), #6-50 Geozone (ID=7071-7115)	S8[160]

7.9 User Interface

7.9.1 Indication Scenario (12500)

0 – Disabled; 1 – Enabled.

Minimum value	Maximum value	Default value	Goes with (depends on) parameters	Value type
0	1	1		Uint8

7.9.2 Sleep Config (12501)

0 – Undefined; 1 – GPS; 2 – Deep; 3 – Online Deep; 4 - Ultra Deep; 5 – GPS + Online Deep; 6 – Deep + Online Deep; 7 – GPS + Deep + Online Deep; 8 – Ultra Deep; 9 – GPS + Ultra Deep; 10 – Deep + Ultra Deep; 11 – GPS + Deep + Ultra Deep; 12 – Online Deep + Ultra Deep; 13 – GPS + Online Deep + Ultra Deep; 14 – Deep + Online Deep + Ultra Deep; 15 – GPS + Deep + Online Deep + Ultra Deep.

Minimum value	Maximum value	Default value	Goes with (depends on) parameters	Value type
0	15	0		Uint8

7.9.3 Led (12502)

0 – Red; 1 – Green; 2 – Blue; 3 – None.

Minimum value	Maximum value	Default value	Goes with (depends on) parameters	Value type
0	3	0		Uint8

7.9.4 Vibration (12503)

0 – Disabled; 1 – Enabled.

Minimum value	Maximum value	Default value	Goes with (depends on) parameters	Value type
0	1	0		Uint8

7.9.5 Period (12504)

LED and vibration period in seconds.

Minimum value	Maximum value	Default value	Goes with (depends on) parameters	Value type
0	3600	15		Uint8

7.9.6 On (ms) (12505)

LED and vibration switching in milliseconds.

Minimum value	Maximum value	Default value	Goes with (depends on) parameters	Value type
0	10000	2000		Uint32

7.9.7 Off (ms) (12506)

LED and vibration shutdown in milliseconds.

Minimum value	Maximum value	Default value	Goes with (depends on) parameters	Value type
0	10000	0		Uint32

7.9.8 Repeat (12507)

Minimum value	Maximum value	Default value	Goes with (depends on) parameters	Value type
0	100	0		Uint32

Table 6. Parameters for GH5200 User Interface

Parameter ID	Parameter Type	Default value	Value range		Parameter name
			Min	Max	
12500	Uint8	1	0	1	GSM Error Setting
12501	Uint8	0	0	15	GSM Error Config
12502	Uint8	0	0	3	GSM Error LED
12503	Uint8	0	0	1	GSM Error Vibration
12504	Uint8	15	0	3600	GSM Error Period
12505	Uint32	2000	0	10000	GSM Error On (ms)
12506	Uint32	0	0	10000	GSM Error Off (ms)
12507	Uint32	0	0	100	GSM Error Repeat
12510	Uint8	1	0	1	GSM Registering Setting
12511	Uint8	0	0	15	GSM Registering Config
12512	Uint8	0	0	3	GSM Registering LED
12513	Uint8	0	0	1	GSM Registering Vibration
12514	Uint8	15	0	3600	GSM Registering Period
12515	Uint32	2000	0	10000	GSM Registering On (ms)
12516	Uint32	0	0	10000	GSM Registering Off (ms)
12517	Uint32	0	0	100	GSM Registering Repeat
12520	Uint8	1	0	1	GSM Send/Receive Setting
12521	Uint8	0	0	15	GSM Send/Receive Config
12522	Uint8	0	0	3	GSM Send/Receive LED
12523	Uint8	0	0	1	GSM Send/Receive Vibration
12525	Uint32	2000	0	10000	GSM Send/Receive On (ms)
12526	Uint32	0	0	10000	GSM Send/Receive Off (ms)
12527	Uint32	0	0	100	GSM Send/Receive Repeat
12530	Uint8	1	0	1	Outgoing Call Setting
12531	Uint8	0	0	15	Outgoing Call Config

Parameter ID	Parameter Type	Default value	Value range		Parameter name
			Min	Max	
12532	Uint8	0	0	3	Outgoing Call LED
12533	Uint8	0	0	1	Outgoing Call Vibration
12534	Uint8	15	0	3600	Outgoing Call Period
12535	Uint32	2000	0	10000	Outgoing Call On (ms)
12536	Uint32	0	0	10000	Outgoing Call Off (ms)
12537	Uint32	0	0	100	Outgoing Call Repeat
12540	Uint8	1	0	1	Remote Connection Setting
12541	Uint8	0	0	15	Remote Connection Config
12542	Uint8	0	0	3	Remote Connection LED
12543	Uint8	0	0	1	Remote Connection Vibration
12544	Uint8	15	0	3600	Remote Connection Period
12545	Uint32	2000	0	10000	Remote Connection On (ms)
12546	Uint32	0	0	10000	Remote Connection Off (ms)
12547	Uint32	0	0	100	Remote Connection Repeat
12550	Uint8	1	0	1	Event Setting
12551	Uint8	0	0	15	Event Config
12552	Uint8	0	0	3	Event LED
12553	Uint8	0	0	1	Event Vibration
12555	Uint32	2000	0	10000	Event On (ms)
12556	Uint32	0	0	10000	Event Off (ms)
12557	Uint32	0	0	100	Event Repeat
12560	Uint8	1	0	1	Panic Event Setting
12561	Uint8	0	0	15	Panic Event Config
12562	Uint8	0	0	3	Panic Event LED
12563	Uint8	0	0	1	Panic Event Vibration
12565	Uint32	2000	0	10000	Panic Event On (ms)
12566	Uint32	0	0	10000	Panic Event Off (ms)
12567	Uint32	0	0	100	Panic Event Repeat
12570	Uint8	1	0	1	No GPS Fix Setting
12571	Uint8	0	0	15	No GPS Fix Config
12572	Uint8	0	0	3	No GPS Fix LED
12573	Uint8	0	0	1	No GPS Fix Vibration
12574	Uint8	15	0	3600	No GPS Fix Period
12575	Uint32	2000	0	10000	No GPS Fix On (ms)
12576	Uint32	0	0	10000	No GPS Fix Off (ms)
12577	Uint32	0	0	100	No GPS Fix Repeat
12580	Uint8	1	0	1	GPS Fix Setting
12581	Uint8	0	0	15	GPS Fix Config
12582	Uint8	0	0	3	GPS Fix LED
12583	Uint8	0	0	1	GPS Fix Vibration
12584	Uint8	15	0	3600	GPS Fix Period
12585	Uint32	2000	0	10000	GPS Fix On (ms)
12586	Uint32	0	0	10000	GPS Fix Off (ms)
12587	Uint32	0	0	100	GPS Fix Repeat
12590	Uint8	1	0	1	Device Off Setting
12591	Uint8	0	0	15	Device Off Config

Parameter ID	Parameter Type	Default value	Value range		Parameter name
			Min	Max	
12592	Uint8	0	0	3	Device Off LED
12593	Uint8	0	0	1	Device Off Vibration
12595	Uint32	2000	0	10000	Device Off On (ms)
12596	Uint32	0	0	10000	Device Off Off (ms)
12597	Uint32	0	0	100	Device Off Repeat
12600	Uint8	1	0	1	Device On Setting
12601	Uint8	0	0	15	Device On Config
12602	Uint8	0	0	3	Device On LED
12603	Uint8	0	0	1	Device On Vibration
12605	Uint32	2000	0	10000	Device On On (ms)
12606	Uint32	0	0	10000	Device On Off (ms)
12607	Uint32	0	0	100	Device On Repeat
12610	Uint8	1	0	1	Alarm Key Pressed Setting
12611	Uint8	0	0	15	Alarm Key Pressed Config
12612	Uint8	0	0	3	Alarm Key Pressed LED
12613	Uint8	0	0	1	Alarm Key Pressed Vibration
12614	Uint8	15	0	3600	Alarm Key Pressed Period
12615	Uint32	2000	0	10000	Alarm Key Pressed On (ms)
12616	Uint32	0	0	10000	Alarm Key Pressed Off (ms)
12617	Uint32	0	0	100	Alarm Key Pressed Repeat
12620	Uint8	1	0	1	Power Key Pressed Setting
12621	Uint8	0	0	15	Power Key Pressed Config
12622	Uint8	0	0	3	Power Key Pressed LED
12623	Uint8	0	0	1	Power Key Pressed Vibration
12624	Uint8	15	0	3600	Power Key Pressed Period
12625	Uint32	2000	0	10000	Power Key Pressed On (ms)
12626	Uint32	0	0	10000	Power Key Pressed Off (ms)
12627	Uint32	0	0	100	Power Key Pressed Repeat
12630	Uint8	1	0	1	Function Activated Setting
12631	Uint8	0	0	15	Function Activated Config
12632	Uint8	0	0	3	Function Activated LED
12633	Uint8	0	0	1	Function Activated Vibration
12635	Uint32	2000	0	10000	Function Activated On (ms)
12636	Uint32	0	0	10000	Function Activated Off (ms)
12637	Uint32	0	0	100	Function Activated Repeat
12640	Uint8	1	0	1	Function Deactivated Setting
12641	Uint8	0	0	15	Function Deactivated Config
12642	Uint8	0	0	3	Function Deactivated LED
12643	Uint8	0	0	1	Function Deactivated Vibration
12645	Uint32	2000	0	10000	Function Deactivated On (ms)
12646	Uint32	0	0	10000	Function Deactivated Off (ms)
12647	Uint32	0	0	100	Function Deactivated Repeat
12650	Uint8	1	0	1	Charging Setting
12651	Uint8	0	0	15	Charging Config
12652	Uint8	0	0	3	Charging LED
12653	Uint8	0	0	1	Charging Vibration

Parameter ID	Parameter Type	Default value	Value range		Parameter name
			Min	Max	
12654	Uint8	15	0	3600	Charging Period
12655	Uint32	2000	0	10000	Charging On (ms)
12656	Uint32	0	0	10000	Charging Off (ms)
12657	Uint32	0	0	100	Charging Repeat
12660	Uint8	1	0	1	Fully Charged Setting
12661	Uint8	0	0	15	Fully Charged Config
12662	Uint8	0	0	3	Fully Charged LED
12663	Uint8	0	0	1	Fully Charged Vibration
12664	Uint8	15	0	3600	Fully Charged Period
12665	Uint32	2000	0	10000	Fully Charged On (ms)
12666	Uint32	0	0	10000	Fully Charged Off (ms)
12667	Uint32	0	0	100	Fully Charged Repeat
12670	Uint8	1	0	1	Pre Alarm Setting
12671	Uint8	0	0	15	Pre Alarm Config
12672	Uint8	0	0	3	Pre Alarm LED
12673	Uint8	0	0	1	Pre Alarm Vibration
12674	Uint8	15	0	3600	Pre Alarm Period
12675	Uint32	2000	0	10000	Pre Alarm On (ms)
12676	Uint32	0	0	10000	Pre Alarm Off (ms)
12677	Uint32	0	0	100	Pre Alarm Repeat
12680	Uint8	1	0	1	Sleep Mode Setting
12681	Uint8	0	0	15	Sleep Mode Config
12682	Uint8	0	0	3	Sleep Mode LED
12683	Uint8	0	0	1	Sleep Mode Vibration
12684	Uint8	15	0	3600	Sleep Mode Period
12685	Uint32	2000	0	10000	Sleep Mode On (ms)
12686	Uint32	0	0	10000	Sleep Mode Off (ms)
12687	Uint32	0	0	100	Sleep Mode Repeat
12690	Uint8	1	0	1	I Am Alive Setting
12691	Uint8	0	0	15	I Am Alive Config
12692	Uint8	0	0	3	I Am Alive LED
12693	Uint8	0	0	1	I Am Alive Vibration
12694	Uint8	15	0	3600	I Am Alive Period
12695	Uint32	2000	0	10000	I Am Alive On (ms)
12696	Uint32	0	0	10000	I Am Alive Off (ms)
12697	Uint32	0	0	100	I Am Alive Repeat

7.10 Keyboard

Keyboard parameters IDs and values.

Parameter ID	Name	Value	
		Possible	Default
13011	Alarm Button 1 Click	0 – None	0

Parameter ID	Name	Value	
13012	Alarm Button 2 Clicks	1 – Alarm	0
13013	Alarm Button Long Click	2 – ManDown On 3 – ManDown Off	0
13014	Power Button 1 Click	4 – ManDown Switch 5 – Auto Geofence On	0
13015	Power Button 2 Clicks	6 – Auto Geofence Off 7 – Auto Geofence Switch	0
13016	Power Button Long Click	8 – Call 9 – SMS	0
13017	1st Button 1 Click	10 - Tracking Switch 11 – Tracking On	0
13018	1st Button 2 Clicks	12 – Tracking Off 13 – Movement Event Switch	0
13019	1st Button Long Click	14 – Movement Event On 15 – Movement Event Off	0
13020	2nd Button 1 Click	16 – Answer	0
13021	2nd Button 2 Clicks	17 – Loud Answer 18 – Hang-up	0
13022	2nd Button Long Click		0
13023	3rd Button 1 Click		
13024	3rd Button 2 Clicks		
13025	3rd Button Long Click		
7265	Alarm Button SMS Action Send To	-	-
8265	Alarm Button SMS Text	Standart SMS event format	None
13031	Alarm Button Call To	-	-
7266	Power Button SMS Action Send To	-	-
8266	Power Button SMS Text	Standart SMS event format	None
13032	Power Button Call To	-	-
7267	1st Button Button SMS Action Send To	-	-
8267	1st Button Button SMS Text	Standart SMS event format	None
13033	1st Button Button Call To	-	-
7268	2nd Button Button SMS Action Send To	-	-

Parameter ID	Name	Value	
8268	2nd Button Button SMS Text	Standart SMS event format	None
13034	2nd Button Button Call To	-	-
7269	3rd Button Button SMS Action Send To	-	-
8269	3rd Button Button SMS Text	Standart SMS event format	None
13035	3rd Button Button Call To	-	-

7.11 Actions

7.11.1 SMS Action

7.11.1.1 SMS Send to (7249)

Enables/disables SMS. 0 – Disable; 1-10 – SMS will be sent to configured GSM number.

Minimum value	Maximum value	Default value	Goes with (depends on) parameters	Value type
0	10	0	GSM Predefined Numbers (ID=6000-6009)	Int32

7.11.1.2 SMS Text (8249)

Configures Keyboard SMS event text.

Minimum value	Maximum value	Default value	Goes with (depends on) parameters	Value type
0	160 char	Keyboard	GSM Predefined Numbers (ID=6000-6009)	S8[160]

7.11.2 Call Action

7.11.2.1 Call to (13010)

Enables/disables call. 0 – Disable; 1-10 – SMS will be sent to configured GSM number.

Minimum value	Maximum value	Default value	Goes with (depends on) parameters	Value type
0	10	0	GSM Predefined Numbers (ID=6000-6009)	Uint8

7.12 Bluetooth

7.12.1.1 BT Radio (ID=800)

Enables/disables Bluetooth. 0 – Disabled; 1 – Enabled (hidden); 2 – Enabled (visible).

Minimum value	Maximum value	Default value	Goes with (depends on) parameters	Value type
0	2	0	Local name (ID 801) Local PIN (ID=802)	Uint8

			Security mode (ID=803) External MAC (ID=804) External name (ID=805) External PIN (ID=806) Connection mode (ID=807) Authorized devices MAC list (ID=830 - 834)	
--	--	--	---	--

7.12.1.2 Local name (ID 801)

This parameter defines the visible name of GH5200 device.

Minimum value	Maximum value	Default value	Goes with (depends on) parameters	Value type
0 Symbols	30 Symbols	GH5200_(last 7 IMEI numbers)	BT Radio (ID=800) Local PIN (ID=802) Security mode (ID=803) External MAC (ID=804) External name (ID=805) External PIN (ID=806) Connection mode (ID=807) Authorized devices MAC list (ID=830 - 834)	S8[30]

7.12.1.3 Local PIN (ID=802)

Parameter allows configuring Bluetooth PIN.

Minimum value	Maximum value	Default value	Goes with (depends on) parameters	Value type
0 Symbols	4 Symbols	5555	BT Radio (ID=800) Local name (ID 801) Security mode (ID=803) External MAC (ID=804) External name (ID=805) External PIN (ID=806) Connection mode (ID=807) Authorized devices MAC list (ID=830 - 834)	String

7.12.1.4 Security mode (ID=803)

Parameter defines a security mode of GH5200 device. 0 – PIN only; 1 – PIN and MAC; 2 - MAC only; 3 – None.

Minimum value	Maximum value	Default value	Goes with (depends on) parameters	Value type
0	3	0	BT Radio (ID=800) Local name (ID 801) Local PIN (ID=802) External MAC (ID=804) External name (ID=805) External PIN (ID=806)	Uint8

			Connection mode (ID=807) Authorized devices MAC list (ID=830 - 834)	
--	--	--	---	--

7.12.1.5 External MAC (ID=804)

Defines external device's MAC, for GH5200 to auto connect to.

Minimum value	Maximum value	Default value	Goes with (depends on) parameters	Value type
0 symbols	12 symbols	0	BT Radio (ID=800) Local name (ID 801) Local PIN (ID=802) Security mode (ID=803) External name (ID=805) External PIN (ID=806) Connection mode (ID=807) Authorized devices MAC list (ID=830 - 834)	String

7.12.1.6 External name (ID=805)

Defines external device's name, for GH5200 to auto connect to.

Minimum value	Maximum value	Default value	Goes with (depends on) parameters	Value type
0 symbols	30 symbols	0	BT Radio (ID=800) Local name (ID 801) Local PIN (ID=802) Security mode (ID=803) External MAC (ID=804) External PIN (ID=806) Connection mode (ID=807) Authorized devices MAC list (ID=830 - 834)	String

7.12.1.7 External PIN (ID=806)

Defines external device's PIN, for GH5200 to auto connect to.

Minimum value	Maximum value	Default value	Goes with (depends on) parameters	Value type
0 symbols	8 symbols	0	BT Radio (ID=800) Local name (ID 801) Local PIN (ID=802) Security mode (ID=803) External MAC (ID=804) External name (ID=805) Connection mode (ID=807) Authorized devices MAC list (ID=830 - 834)	String

7.12.1.8 Connection mode (ID=807)

Defines a mode in which GH5200 will connect to external devices. 0 – None, 1 – GH5200 will connect to Hands Free Headset; 2 – Data Link.

Minimum value	Maximum value	Default value	Goes with (depends on) parameters	Value type
0	2	0	BT Radio (ID=800) Local name (ID 801) Local PIN (ID=802) Security mode (ID=803) External MAC (ID=804) External name (ID=805) External PIN (ID=806) Authorized devices MAC list (ID=830 - 834)	Uint8

7.12.1.9 Authorized devices MAC list (ID=830 - 834)

This parameter allows adding an authorized devices MAC for connection to GH5200.

Minimum value	Maximum value	Default value	Goes with (depends on) parameters	Value type
0 symbols	12 symbols	-	BT Radio (ID=800) Local name (ID 801) Local PIN (ID=802) Security mode (ID=803) External MAC (ID=804) External name (ID=805) External PIN (ID=806) Connection mode (ID=807)	String

7.13 I/O parameters

I/O properties are additional data sources which are recorded along with usual GPS data.

7.13.1 I/O#1 property parameter priority (ID=50010)

This parameter defines I/O property priority: 0 – Disabled; 1 – Low; 2 – High; 3 - Panic.

Minimum value	Maximum value	Default value	Goes with (depends on) parameters	Value type
0	3	2	I/O#1 operand (ID=50011)/I/O#1 High level (ID=50012) I/O#1 Low level (ID=50013) I/O#1 Event only (ID=50014) I/O#1 averaging length (ID=50015) I/O#1 send SMS (ID=7000) I/O#1 SMS text (ID=8000)	Uint8

7.13.2 I/O#1 operand (ID=50011)

This parameter defines when event is sent: 0 – On range exit; 1 – On range entrance; 2 – Both; 3 – Monitoring; 4 – Hysteresis; 5 – On changes; 6 – On delta change.

Minimum value	Maximum value	Default value	Goes with (depends on) parameters	Value type
0	6	5	I/O#1 property parameter priority (ID=50010) I/O#1 High level (ID=50012) I/O#1 Low level (ID=50013) I/O#1 Event only (ID=50014) I/O#1 averaging length (ID=50015) I/O#1 send SMS (ID=7000) I/O#1 SMS text (ID=8000)	Uint8

7.13.3 I/O#1 High level (ID=50012)

This parameter defines high value of triggered I/O property. This parameter is used to set thresholds for I/O properties to generate events.

Minimum value	Maximum value	Default value	Goes with (depends on) parameters	Value type
0	1	0	I/O#1 property parameter priority (ID=50010) I/O#1 operand (ID=50011) I/O#1 Low level (ID=50013) I/O#1 Event only (ID=50014) I/O#1 averaging length (ID=50015) I/O#1 send SMS (ID=7000) I/O#1 SMS text (ID=8000)	Uint8

7.13.4 I/O#1 Low level (ID=50013)

This parameter defines low value of triggered I/O property. This parameter is used to set thresholds for I/O properties to generate events.

Minimum value	Maximum value	Default value	Goes with (depends on) parameters	Value type
0	1	0	I/O#1 property parameter priority (ID=50010) I/O#1 operand (ID=50011) I/O#1 High level (ID=50012) I/O#1 Event only (ID=50014) I/O#1 averaging length (ID=50015) I/O#1 send SMS (ID=7000) I/O#1 SMS text (ID=8000)	Uint8

7.13.5 I/O#1 Event only (ID=50014)

This parameter defines when I/O element value is sent: 0 – With every AVL packet; 1 – On event only. On event means that I/O element value is included to AVL packet only when this particular event happens. With regular, periodic records such I/O element value is not included.

Minimal value	Maximum value	Default value	Goes with (depends on) parameters	Value type

0	1	0	I/O#1 property parameter priority (ID=50010) I/O#1 operand (ID=50011)/I/O#1 High level (ID=50012) I/O#1 Low level (ID=50013) I/O#1 averaging length (ID=50015) I/O#1 send SMS (ID=7000) I/O#1 SMS text (ID=8000)	Uint8
---	---	---	---	-------

7.13.6 I/O#1 averaging length (ID=50015)

This parameter defines I/O property sample length used for averaging.

Minimum value	Maximum value	Default value	Goes with (depends on) parameters	Value type
0	65535	1	I/O#1 property parameter priority (ID=50010) I/O#1 operand (ID=50011)/I/O#1 High level (ID=50012) I/O#1 Low level (ID=50013) I/O#1 Event only (ID=50014) I/O#1 send SMS (ID=7000) I/O#1 SMS text (ID=8000)	Uint16

7.13.7 I/O#1 send SMS (ID=7001)

Enables/disables SMS. 0 – Disable; 1-10 – SMS will be sent to configured GSM number.

Minimum value	Maximum value	Default value	Goes with (depends on) parameters	Value type
0	10	0	GSM Predefined Numbers (ID=6000-6009) I/O#1 property parameter priority (ID=50010) I/O#1 operand (ID=50011)/I/O#1 High level (ID=50012) I/O#1 Low level (ID=50013) I/O#1 Event only (ID=50014) I/O#1 SMS text (ID=8000)	Uint8

7.13.8 I/O#1 SMS text (ID=8001)

Configures I/O#1 SMS event text.

Minimum value	Maximum value	Default value	Goes with (depends on) parameters	Value type
---------------	---------------	---------------	-----------------------------------	------------

0	160	Movement	I/O#1 property parameter priority (ID=50010) I/O#1 operand (ID=50011)/I/O#1 High level (ID=50012) I/O#1 Low level (ID=50013) I/O#1 Event only (ID=50014) I/O#1 send SMS (ID=7000)	S8[160]
---	-----	----------	---	---------

7.13.9 I/O elements parameters and types

Priority: 0 – Disabled; 1 – Low; 2 – High; 3 – Panic.

Operand: 0 – On Exit; 1 – On Entrance; 2 – On Both; 3 – Monitoring; 4 – On Hysteresis; 5 - On Change; 6 – On Delta Change.

Event only: 0 – No; 1 – Yes.

Table 7. Parameters for GH5200 devices

Parameter ID	Parameter Type	Default value	Value range		Parameter name
			Min	Max	
50010	Uint8	1	0	3	Movement Priority
50011	Uint8	5	0	6	Movement Operand
50012	Uint8	0	0	1	Movement High level
50013	Uint8	0	0	1	Movement Low level
50014	Uint8	0	0	1	Movement Event only
50015	Uint16	1	0	65535	Movement Average
7001	Uint8	0	0	10	Send SMS
8001	String	0	0	160	SMS Text
50020	Uint8	1	0	3	Data Mode Priority
50021	Uint8	3	0	6	Data Mode Operand
50022	Uint8	0	0	5	Data Mode High level
50023	Uint8	0	0	5	Data Mode Low level
50024	Uint8	0	0	1	Data Mode Event only
7002	Uint8	0	0	10	Send SMS
8002	String	0	0	160	SMS Text
50030	Uint8	1	0	3	GSM Signal Priority
50031	Uint8	3	0	6	GSM Signal Operand
50032	Uint8	0	0	5	GSM Signal High level
50033	Uint8	0	0	5	GSM Signal Low level
50034	Uint8	0	0	1	GSM Signal Event only
50035	Uint16	1	0	65535	GSM Signal Average
7003	Uint8	0	0	10	Send SMS
8003	String	0	0	160	SMS Text
50040	Uint8	1	0	3	Sleep Priority
50041	Uint8	3	0	6	Sleep Operand
50042	Uint8	0	0	2	Sleep High level
50043	Uint8	0	0	2	Sleep Low level
50044	Uint8	0	0	1	Sleep Event only
7004	Uint8	0	0	10	Send SMS

Parameter ID	Parameter Type	Default value	Value range		Parameter name
			Min	Max	
8004	String	0	0	160	SMS Text
50050	Uint8	1	0	3	GNSS Status Priority
50051	Uint8	3	0	6	GNSS Status Operand
50052	Uint8	0	0	5	GNSS Status High level
50053	Uint8	0	0	5	GNSS Status Low level
50053	Uint8	0	0	1	GNSS Status Event only
7005	Uint8	0	0	10	Send SMS
8005	String	0	0	160	SMS Text
50060	Uint8	0	0	3	GNSS PDOP Priority
5061	Uint8	3	0	6	GNSS PDOP Operand
5062	Uint16	0	0	1000	GNSS PDOP High level
5063	Uint16	0	0	1000	GNSS PDOP Low level
5064	Uint8	0	0	1	GNSS PDOP Event only
5065	Uint16	10	0	65535	GNSS PDOP Average
7006	Uint8	0	0	10	Send SMS
8006	String	0	0	160	SMS Text
50070	Uint8	1	0	3	GNSS HDOP Priority
50071	Uint8	3	0	6	GNSS HDOP Operand
50072	Uint16	0	0	1000	GNSS HDOP High level
50073	Uint16	0	0	1000	GNSS HDOP Low level
50074	Uint8	0	0	1	GNSS HDOP Event only
50075	Uint16	10	0	65535	GNSS HDOP Average
7007	Uint8	0	0	10	Send SMS
8007	String	0	0	160	SMS Text
50100	Uint8	0	0	3	GSM Cell ID Priority
50101	Uint8	3	0	6	GSM Cell ID Operand
50102	Uint32	0	0	999999	GSM Cell ID High level
50103	Uint32	0	0	999999	GSM Cell ID Low level
50104	Uint8	0	0	1	GSM Cell ID Event only
7010	Uint8	0	0	10	Send SMS
8010	String	0	0	160	SMS Text
50110	Uint8	0	0	3	GSM Area Code Priority
50111	Uint8	3	0	6	GSM Area Code Operand
50112	Uint32	0	0	999999	GSM Area Code High level
50113	Uint32	0	0	999999	GSM Area Code Low level
50114	Uint8	0	0	1	GSM Area Code Event only
7011	Uint8	0	0	10	Send SMS
8011	String	0	0	160	SMS Text
50120	Uint8	1	0	3	Battery Voltage Priority
50121	Uint8	3	0	6	Battery Voltage Operand
50122	Uint16	0	0	5000	Battery Voltage High level
50123	Uint16	0	0	5000	Battery Voltage Low level
50124	Uint8	0	0	1	Battery Voltage Event only
50125	Uint8	0	0	10	Battery Voltage Average
7012	Uint8	0	0	10	Send SMS
8012	String	0	0	160	SMS Text

Parameter ID	Parameter Type	Default value	Value range		Parameter name
			Min	Max	
50660	Uint8	0	0	3	Battery Level Priority
50661	Uint8	3	0	6	Battery Level Operand
50662	Uint16	0	0	1000	Battery Level High level
50663	Uint16	0	0	1000	Battery Level Low level
50664	Uint8	0	0	1	Battery Level Event only
7013	Uint8	0	0	10	Send SMS
8243	String	0	0	160	SMS Text
50140	Uint8	0	0	3	Active GSM Operator Priority
50141	Uint8	3	0	6	Active GSM Operator Operand
50142	Uint32	0	0	999999	Active GSM Operator High level
50143	Uint32	0	0	999999	Active GSM Operator Low level
50144	Uint8	0	0	1	Active GSM Operator Event only
7014	Uint8	0	0	10	Send SMS
8014	String	0	0	160	SMS Text
50150	Uint8	0	0	3	Charger Connected Priority
50151	Uint8	3	0	6	Charger Connected Operand
50152	Uint32	0	0	1	Charger Connected High level
50153	Uint32	0	0	1	Charger Connected Low level
50154	Uint8	0	0	1	Charger Connected Event only
7014	Uint8	0	0	10	Send SMS
8244	String	0	0	160	SMS Text
50160	Uint8	0	0	3	Total Odometer Priority
50161	Uint8	3	0	6	Total Odometer Operand
50162	Uint32	0	0	10000000	Total Odometer High level
50163	Uint32	0	0	10000000	Total Odometer Low level
50164	Uint8	0	0	1	Total Odometer Event only
7016	Uint8	0	0	10	Send SMS
8016	String	0	0	160	SMS Text
50170	Uint8	0	0	3	Digital Input 1 Priority
50171	Uint8	3	0	6	Digital Input 1 Operand
50172	Uint8	0	0	1	Digital Input 1 High level
50173	Uint8	0	0	1	Digital Input 1 Low level
50174	Uint8	0	0	1	Digital Input 1 Event only
50175	Uint16	1	0	65535	Digital Input 1 Average
7017	Uint8	0	0	10	Send SMS
8017	String	0	0	160	SMS Text
50180	Uint8	0	0	3	Analog Input 1 Priority
50181	Uint8	3	0	6	Analog Input 1 Operand
50182	Uint16	0	0	30000	Analog Input 1 High level
50183	Uint16	0	0	30000	Analog Input 1 Low level
50184	Uint8	0	0	1	Analog Input 1 Event only
50185	Uint16	10	0	65535	Analog Input 1 Average
7018	Uint8	0	0	10	Send SMS
8018	String	0	0	160	SMS Text
50190	Uint8	0	0	3	Digital Output 1 Priority
50191	Uint8	0	0	6	Digital Output 1 Operand

Parameter ID	Parameter Type	Default value	Value range		Parameter name
			Min	Max	
50192	Uint8	0	0	1	Digital Output 1 High level
50193	Uint8	0	0	1	Digital Output 1 Low level
50194	Uint8	0	0	1	Digital Output 1 Event only
50195	Uint16	1	0	65535	Digital Output 1 Average
7019	Uint8	0	0	10	Send SMS
8019	String	0	0	160	SMS Text
50200	Uint8	0	0	3	Fuel Used GPS Priority
50201	Uint8	3	0	6	Fuel Used GPS Operand
50202	Uint32	0	0	1000000	Fuel Used GPS High level
50203	Uint32	0	0	1000000	Fuel Used GPS Low level
50204	Uint8	0	0	1	Fuel Used GPS Event only
50205	Uint16	1	0	65535	Fuel Used GPS Average
7020	Uint8	0	0	10	Send SMS
8020	String	0	0	160	SMS Text
50210	Uint8	0	0	3	Fuel Rate GPS Priority
50211	Uint8	3	0	6	Fuel Rate GPS Operand
50212	Uint32	0	0	1000000	Fuel Rate GPS High level
50213	Uint32	0	0	1000000	Fuel Rate GPS Low level
50214	Uint8	0	0	1	Fuel Rate GPS Event only
50215	Uint16	1	0	65535	Fuel Rate GPS Average
7021	Uint8	0	0	10	Send SMS
8021	String	0	0	160	SMS Text
50220	Uint8	0	0	3	Axis X Priority
50221	Uint8	3	0	6	Axis X Operand
50222	Uint16	0	-8000	8000	Axis X High level
50223	Uint16	0	-8000	8000	Axis X Low level
50224	Uint8	0	0	1	Axis X Event only
50225	Uint16	1	0	65535	Axis X Average
7022	Uint8	0	0	10	Send SMS
8022	String	0	0	160	SMS Text
50230	Uint8	0	0	3	Axis Y Priority
50231	Uint8	3	0	6	Axis Y Operand
50232	Uint16	0	-8000	8000	Axis Y High level
50233	Uint16	0	-8000	8000	Axis Y Low level
50234	Uint8	0	0	1	Axis Y Event only
50235	Uint16	1	0	65535	Axis Y Average
7023	Uint8	0	0	10	Send SMS
8023	String	0	0	160	SMS Text
50240	Uint8	0	0	3	Axis Z Priority
50241	Uint8	3	0	6	Axis Z Operand
50242	Uint16	0	-8000	8000	Axis Z High level
50243	Uint16	0	-8000	8000	Axis Z Low level
50244	Uint8	0	0	1	Axis Z Event only
50245	Uint16	1	0	65535	Axis Z Average
7024	Uint8	0	0	10	Send SMS
8024	String	0	0	160	SMS Text

Parameter ID	Parameter Type	Default value	Value range		Parameter name
			Min	Max	
50250	UInt8	0	0	3	ICCID Priority
50251	UInt8	3	0	6	ICCID Operand
50254	UInt8	0	0	1	ICCID Event only
7069	UInt8	0	0	10	Send SMS
8069	String	0	0	160	SMS Text

8 DEBUG MODE

GH5200 device is able to provide its debug trace when it is connected to PC using the magnetic USB cable. This trace can be used to detect errors and provide debug information if the device functions not as expected. Required Terminal application can be downloaded using: <http://avl1.teltonika.lt/Downloads/Software/Terminal.zip>

When powered on GH5200 device is connected to PC, two ports are created:

MTK USB Modem Port is used for modem trace;

MTK USB Debug Port is used for Terminal log.

If connected GH5200 device is not recognized by PC, please install the required drivers. Following link can be used: <http://avl1.teltonika.lt/Downloads/FMB1/>

After selecting your port click **Connect** and then click on **Start Log** button. If the log is not running, please send **.log:1** command (see picture below).

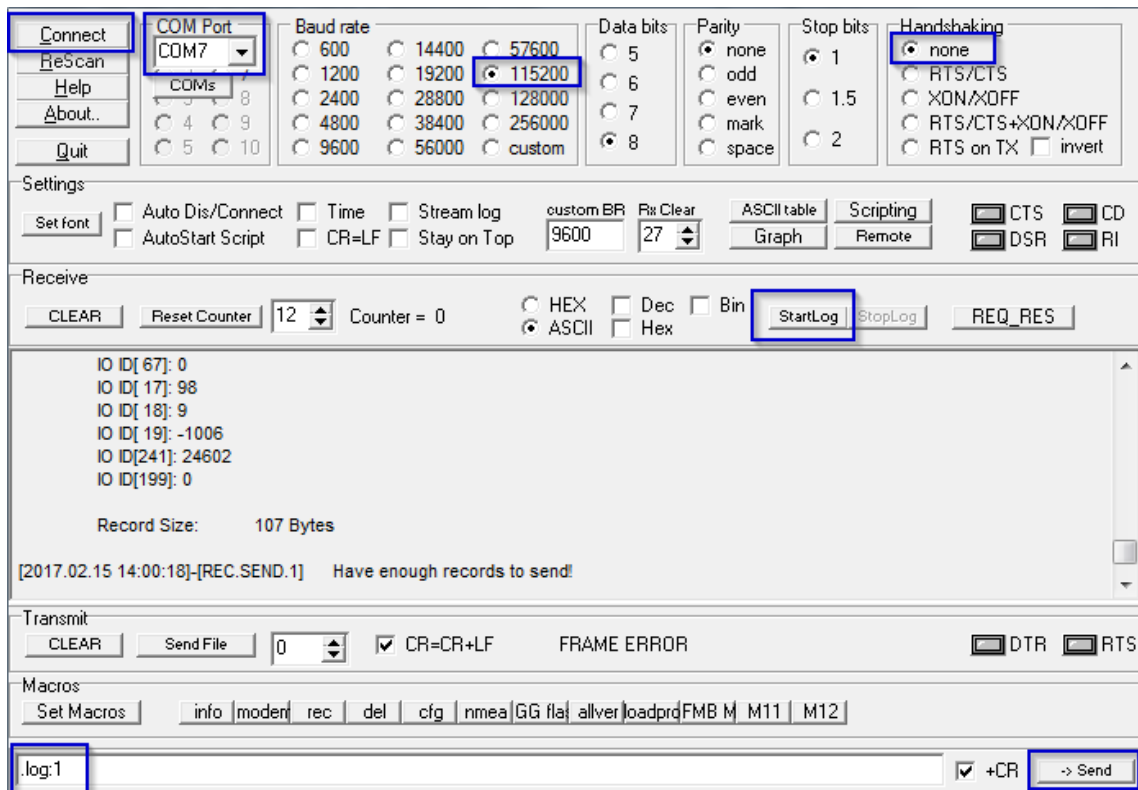

Figure 38 Terminal.exe window

9 CHANGE LOG

Nr.	Date	Version	Comments
1	2019-03-21	1.0	Preliminary release.